

Name	Nice 6x6 Lux Mezzanine 595x595_44		
Zeichnung/Drawing	3D	VS44_NICE6x6LUXMEZ	
Profil/Profile	4.4x13.5	Maßstab/Scale	Druck auf/ Print on
			Datum/Date 18.05.2026

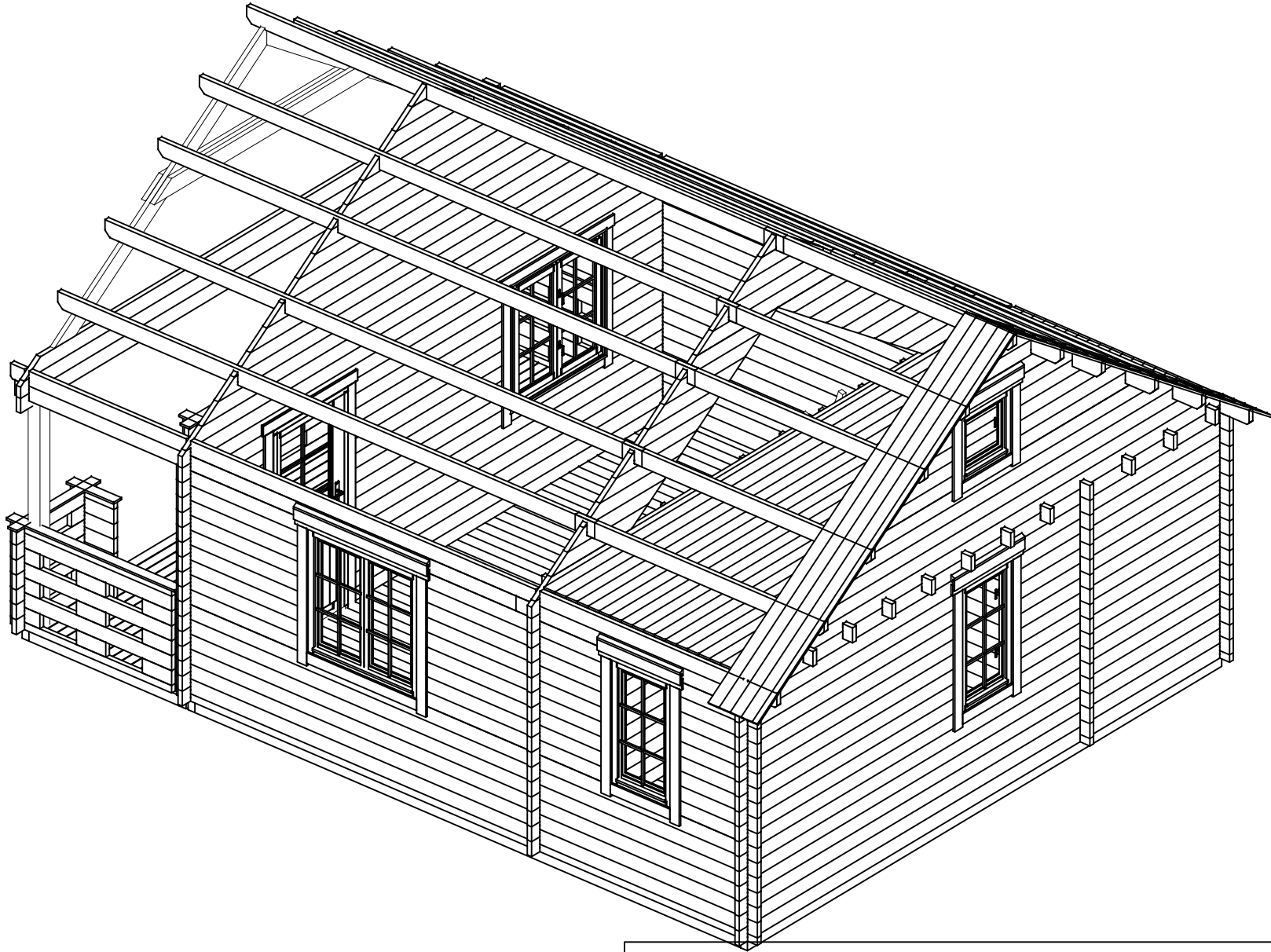

Name	Nice 6x6 Lux Mezzanine 595x595_44		
Zeichnung/Drawing	3D	VS44_NICE6x6LUXMEZ	
Profil/Profile	4.4x13.5	Maßstab/Scale	Druck auf/ Print on
			Datum/Date 18.05.2026

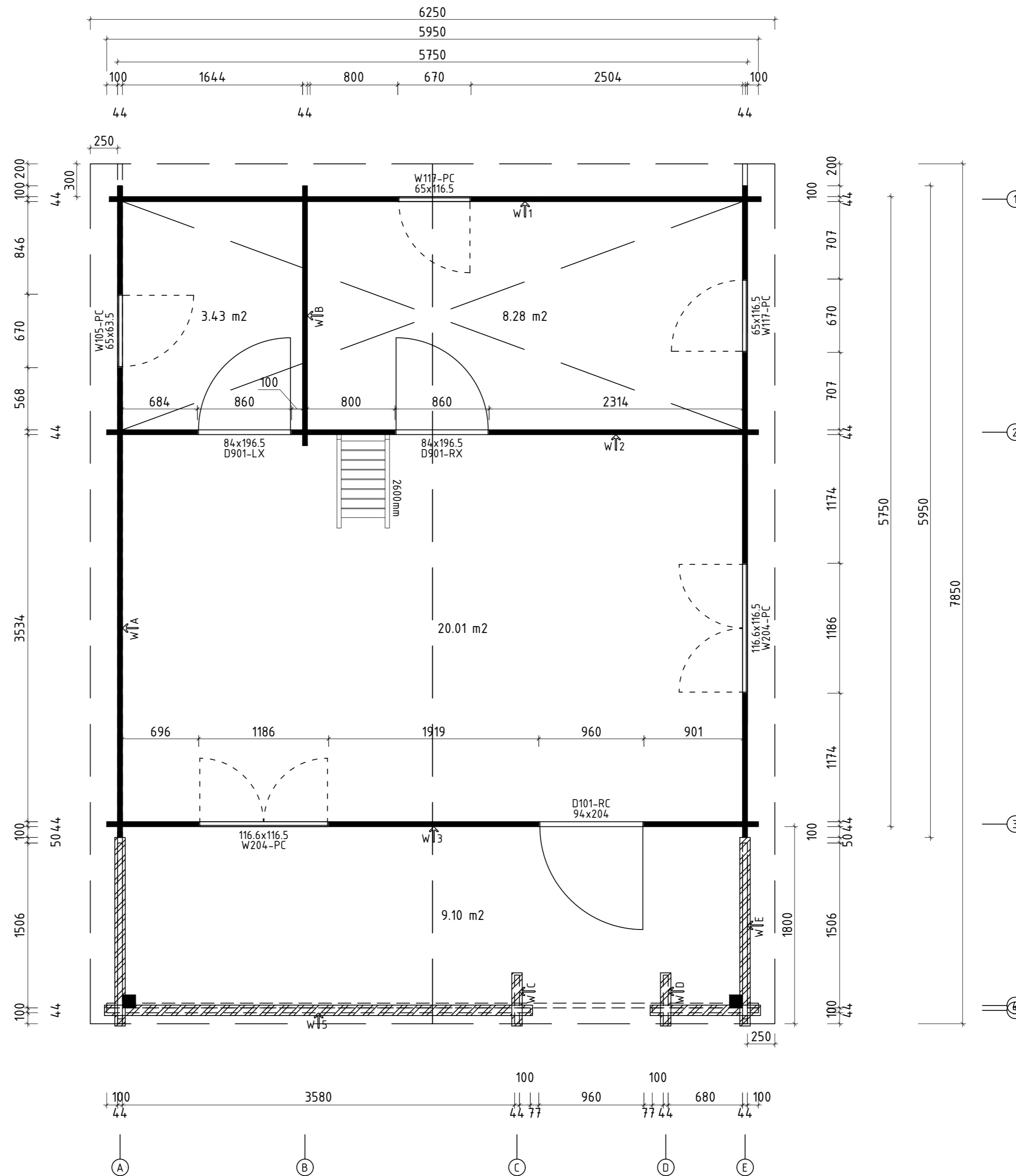

Fenster / window mezzanine

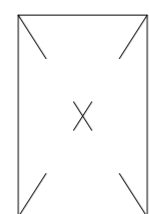
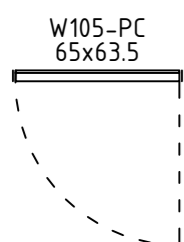

- Schlafboden/sleeping floor

\* Fenster und Türen sind mit Sprossen/  
Windows and doors are with muntins  
**Q3**- Qualitätsklasse für Fenster und Türen/  
Quality class for windows and doors



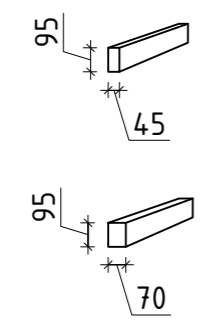
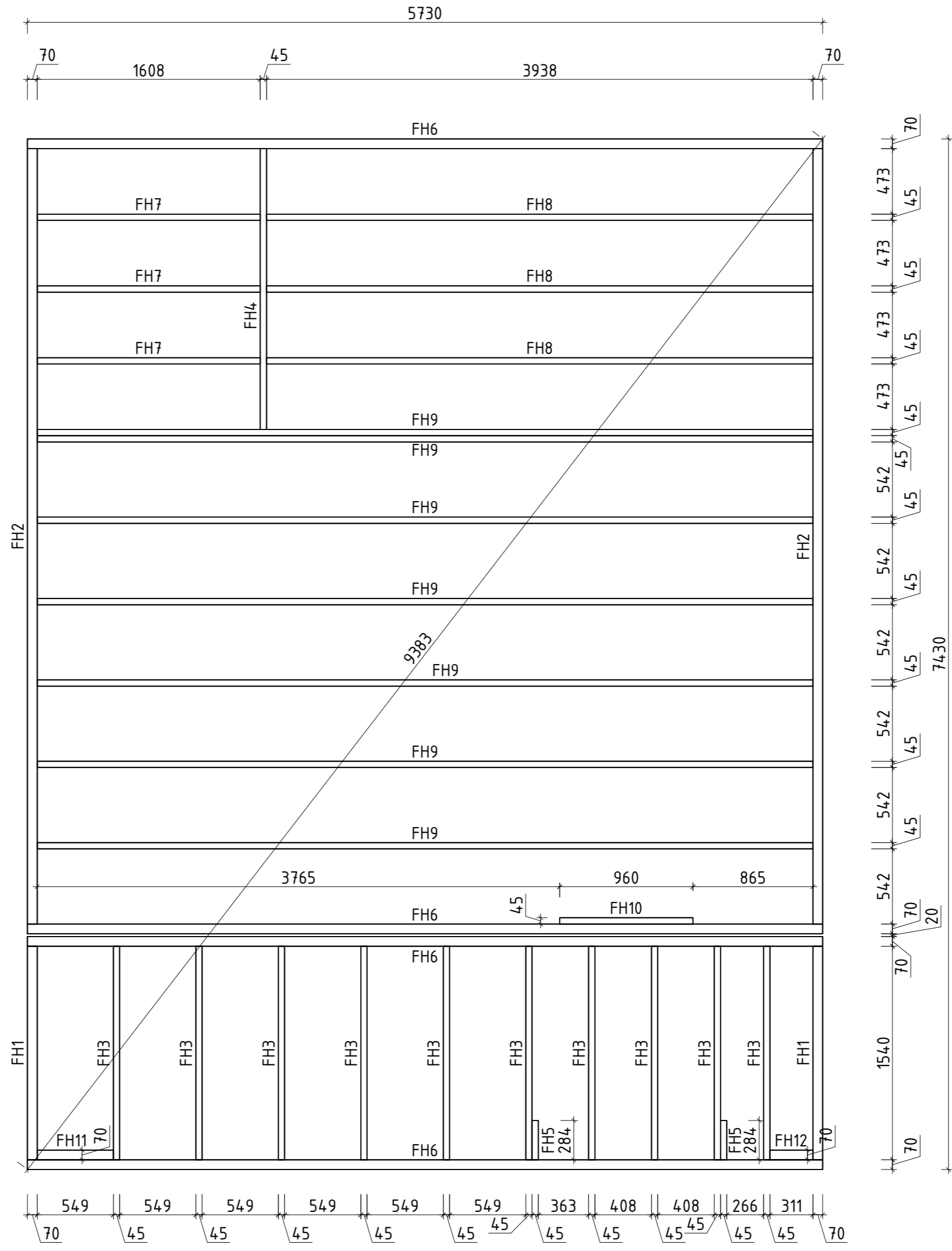



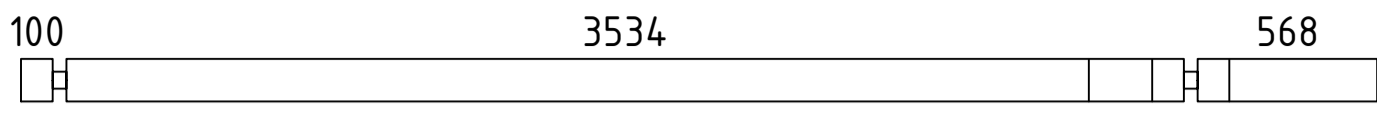
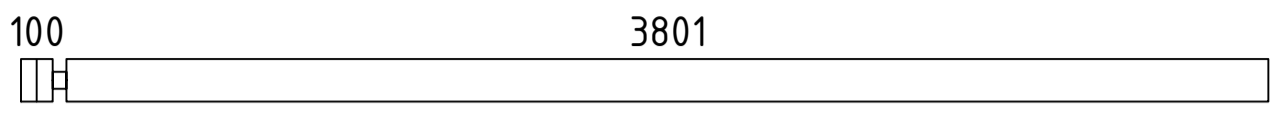
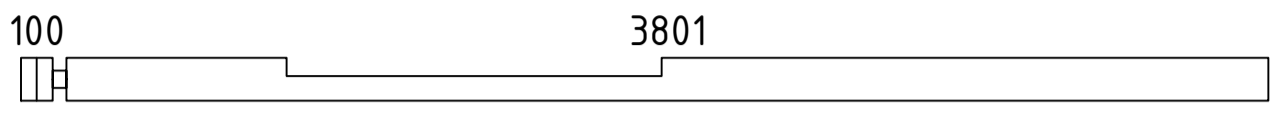
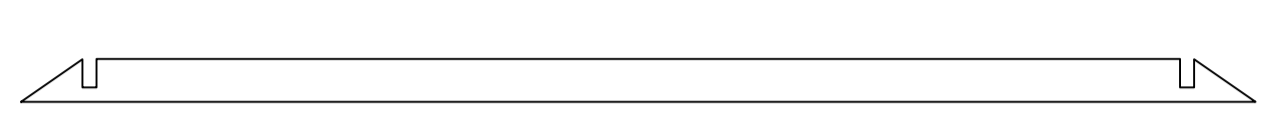
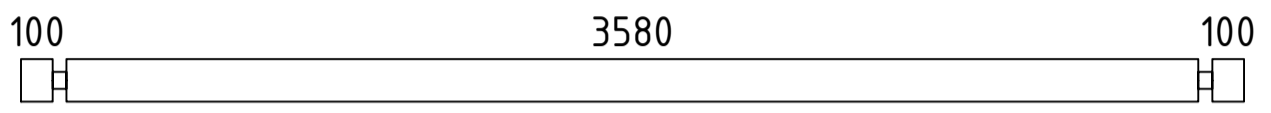
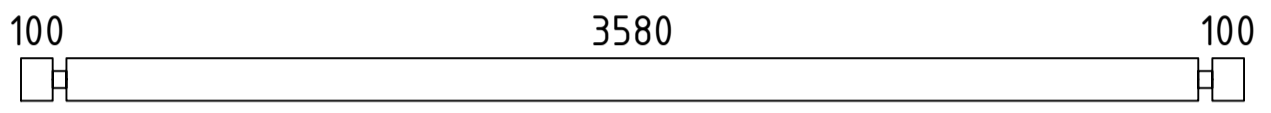
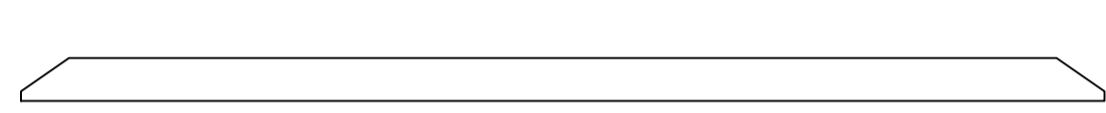
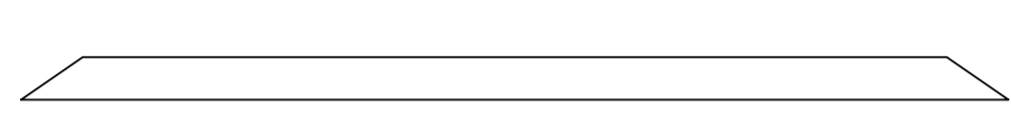
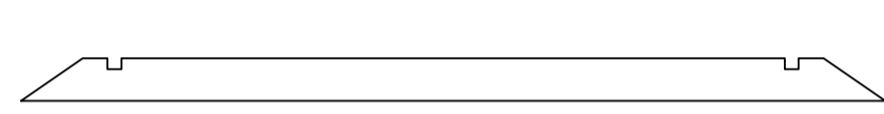
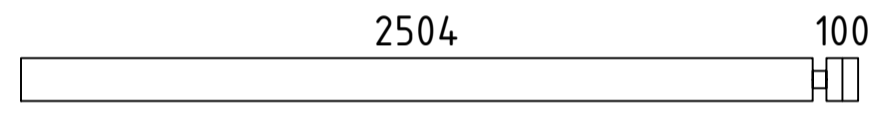
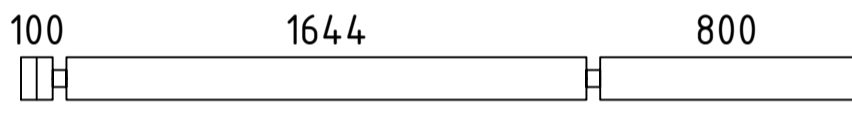
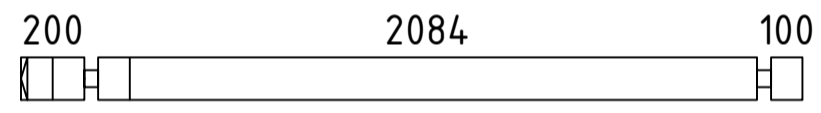
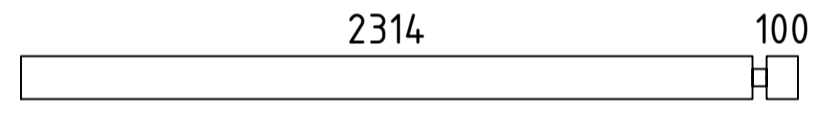
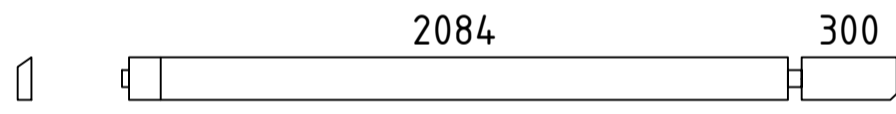
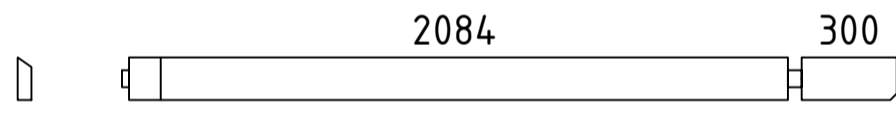
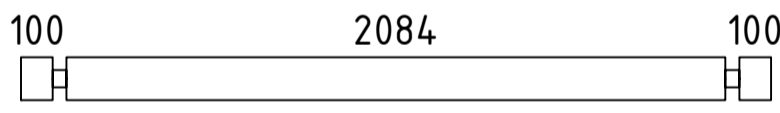
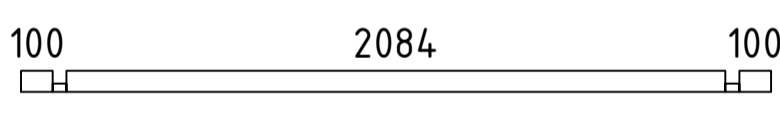
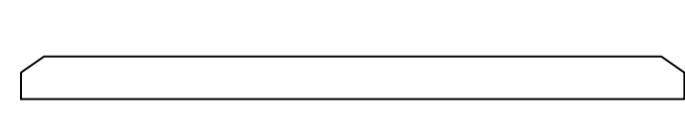
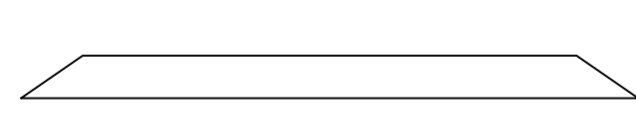
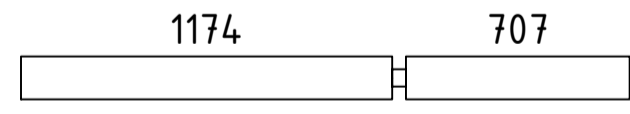
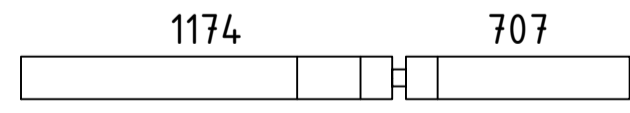
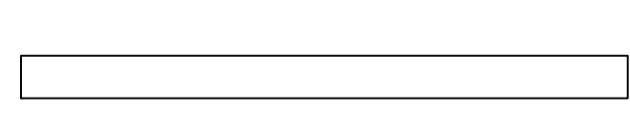
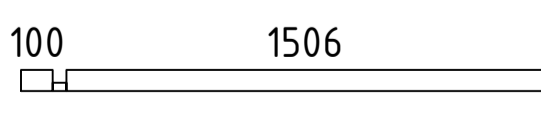
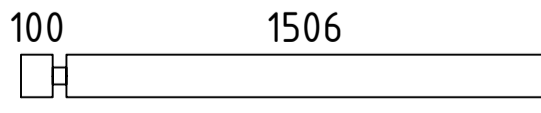
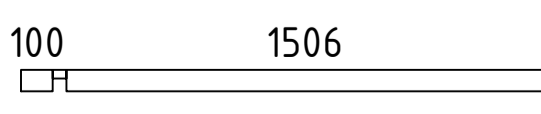

Name	Nice 6x6 Lux Mezzanine 595x595_44		
Zeichnung/Drawing	Grundplan_Plan	VS44_NICE6x6LUXMEZ	
Profil/Profile	4.4x13.5	Maßstab/Scale	1:30
Druck auf/Print on	A2	Datum/Date	18.05.2026

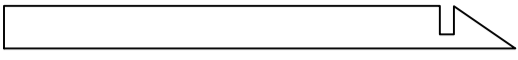
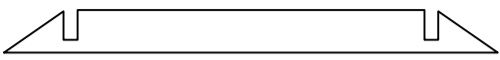
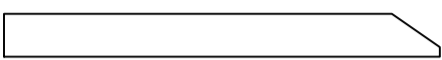
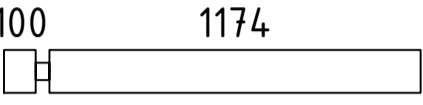
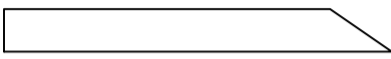
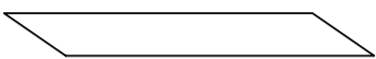

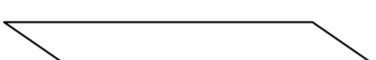
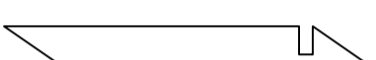
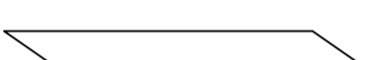

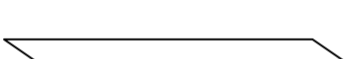

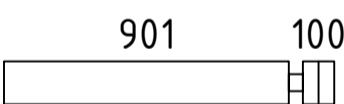
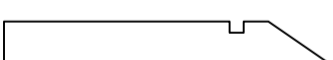
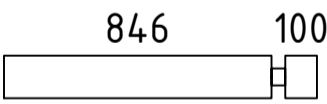
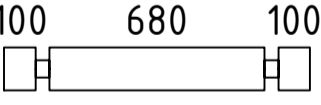
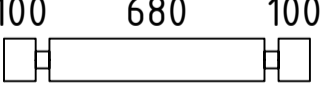
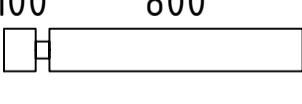
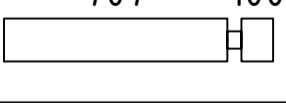
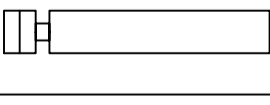
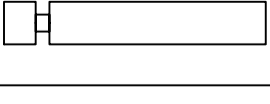

Name	Nice 6x6 Lux Mezzanine 595x595_44		
Zeichnung/Drawings	Lagerholzplan_Foundation beams VS44_NICE6x6LUXMEZ		
Profil/Profile	4.4x13.5	Maßstab/Scale	1:30
Druck auf/Print on	A2	Datum/Date	18.05.2026



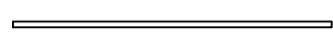
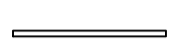
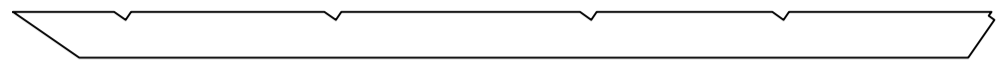
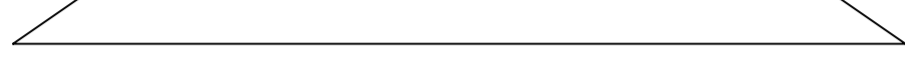
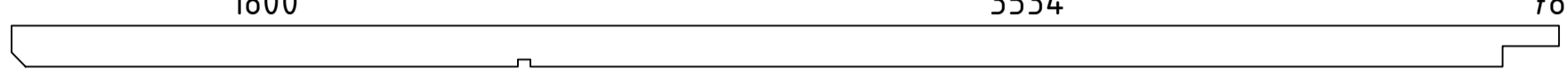
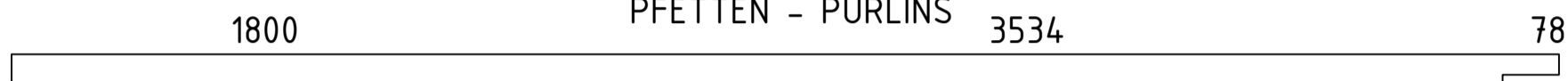

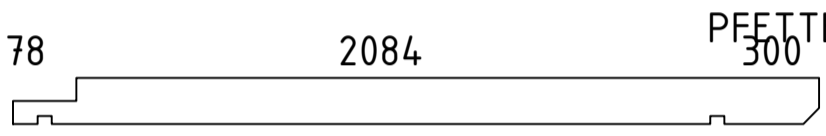
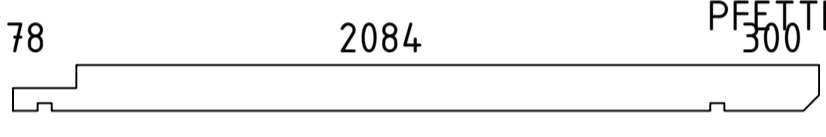
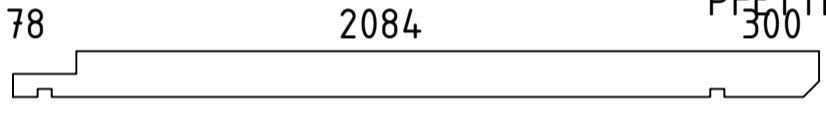
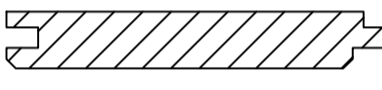
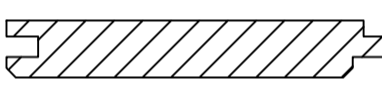
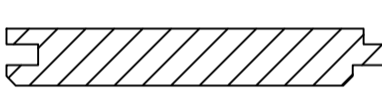

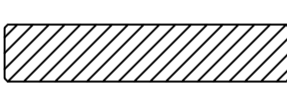

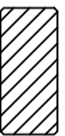
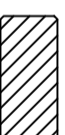
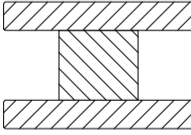
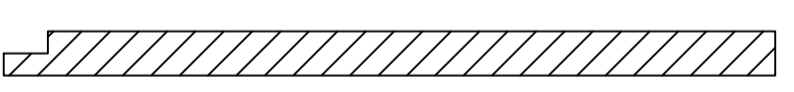
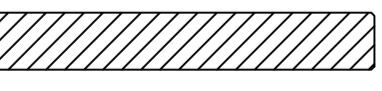
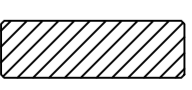
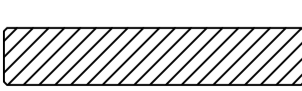
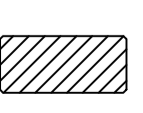
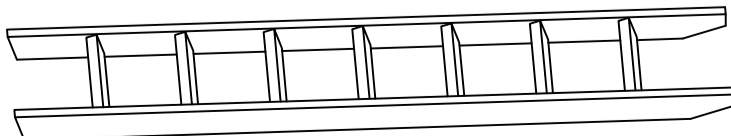
Pos	Teieliste/Specification Nice 6x6 Lux Mezzanine 595x595_44	Pcs.	Profile (mm)	Length (mm)
	Achtung! Die Giebelbohlen können teilweise schon vormontiert sein! Bitte beachten - diese erscheinen nicht ganz so wie in der Teieliste beschrieben.			
	Notice! The gable pieces can be partly pre-assembled! Please notice - those differ from the description given in the specification list.			
1extra		1	44x135	5950
001		1	44x135	5950
002		1	44x135	5950
003		1	44x135	5950
004		1	44x135	5950
005		2	44x68	5950
006		16	44x135	5950
007		1	44x135	5950
008		1	44x135	5950
009		1	44x135	5950
010		1	44x135	5950
011		1	44x135	5950
012		6	44x135	5950
013		1	44x135	5857
014		1	44x135	5857
015		1	44x135	5857
016		1	44x135	5857
017		2	44x135	5467
018		1	44x135	5400
019		1	44x135	5400
020		2	44x135	5134
021		2	44x135	5076
022		2	44x135	4521
023		2	44x135	4295
024		4	44x135	4290
Kood	Nice 6x6 Lux Mezzanine 595x595_44	Materjal		Leht 1/13

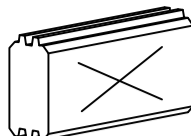
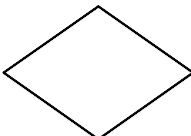
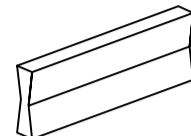
Pos	Teileliste/Specification Nice 6x6 Lux Mezzanine 595x595_44	Pcs.	Profile (mm)	Length (mm)
025		1	44x135	4290
026		6	44x135	3945
027		1	44x135	3945
028		1	44x135	3905
029		1	44x135	3868
030		3	44x135	3868
031		1	44x135	3428
032		1	44x135	3124
033		1	44x135	2733
034		8	44x135	2648
035		8	44x135	2632
036		2	44x135	2472
037		15	44x135	2458
038		1	44x135	2450
039		1	44x135	2450
040		17	44x135	2372
041		1	44x68	2372
042		1	44x135	2098
043		3	44x135	1952
044		8	44x135	1925
045		1	44x135	1925
046		8	44x135	1919
047		2	44x68	1650
048		6	44x135	1650
049		2	44x68	1650
Kood	Nice 6x6 Lux Mezzanine 595x595_44	Materjal		Leht 2/13

Pos	Teileliste/Specification Nice 6x6 Lux Mezzanine 595x595_44	Pcs.	Profile (mm)	Length (mm)
050		2	44x135	1617
051		3	44x135	1562
052		2	44x135	1379
053		9	44x135	1318
054		2	44x135	1227
055		2	44x135	1171
056		2	44x135	1171
057		2	44x135	1171
058		2	44x135	1171
059		2	44x135	1171
060		2	44x135	1171
061		2	44x135	1128
062		3	44x135	1097
063		2	44x135	1089
064		1	44x135	1049
065		1	44x135	1049
066		15	44x135	1045
067		2	44x135	1032
068		5	44x135	990
069		1	44x135	968
070		3	44x135	968
071		15	44x135	944
072		9	44x135	851
073		8	44x135	840
074		15	44x135	828
Kood	Nice 6x6 Lux Mezzanine 595x595_44	Materjal		Leht 3/13

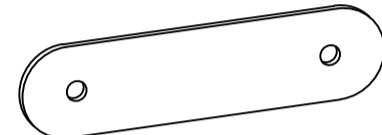
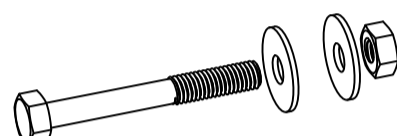
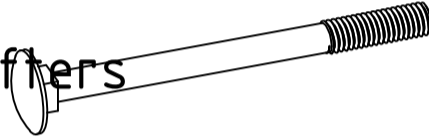
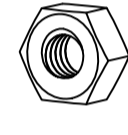
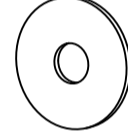
Pos	Teileliste/Specification Nice 6x6 Lux Mezzanine 595x595_44		Pcs.	Profile (mm)	Length (mm)
075			3	44x135	781
076			2	44x135	714
077	100 300 		2	44x68	444
078	100 300 		12	44x135	444
079	100 300 		2	44x68	444
080			24	44x135	300
081	100156 		18	44x135	300
082			6	44x120	173
083			6	44x54	78
084			6	44x27	38
ÜT1	100 2084 100 	KANT_TALA	11	44x135	2372
FH6	FUNDAMENTHOLZ (imprägniert) - FOUNDATION BEAM (impregnated) 		4	70x95	5730
FH2	FUNDAMENTHOLZ (imprägniert) - FOUNDATION BEAM (impregnated) 		2	70x95	5590
FH1	FUNDAMENTHOLZ (imprägniert) - FOUNDATION BEAM (impregnated) 		2	70x95	1540
FH11	FUNDAMENTHOLZ (imprägniert) - FOUNDATION BEAM (impregnated) 		1	70x95	549
FH12	FUNDAMENTHOLZ (imprägniert) - FOUNDATION BEAM (impregnated) 		1	70x95	310
FH9	FUNDAMENTHOLZ (imprägniert) - FOUNDATION BEAM (impregnated) 		7	45x95	5590
FH8	FUNDAMENTHOLZ (imprägniert) - FOUNDATION BEAM (impregnated) 		3	45x95	3938
FH4	FUNDAMENTHOLZ (imprägniert) - FOUNDATION BEAM (impregnated) 		1	45x95	2025
FH7	FUNDAMENTHOLZ (imprägniert) - FOUNDATION BEAM (impregnated) 		3	45x95	1608
FH3	FUNDAMENTHOLZ (imprägniert) - FOUNDATION BEAM (impregnated) 		10	45x95	1540
FH10	FUNDAMENTHOLZ (imprägniert) - FOUNDATION BEAM (impregnated) 		1	45x95	960
FH5	FUNDAMENTHOLZ (imprägniert) - FOUNDATION BEAM (impregnated) 		2	45x95	284
HL3	HANDLAUF - HANDRAIL 		✓ 1	95x18	3908
HL1	HANDLAUF - HANDRAIL 		✓ 2	95x18	1720
Kood	Nice 6x6 Lux Mezzanine 595x595_44		Materjal		Leht 4/13

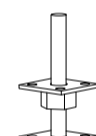
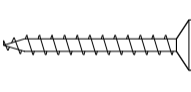
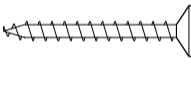
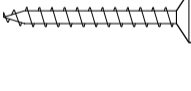
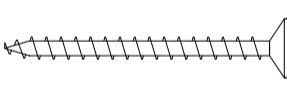
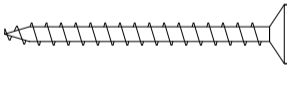
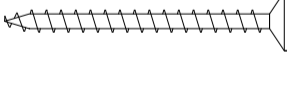
Pos	Teileliste/Specification Nice 6x6 Lux Mezzanine 595x595_44		Pcs.	Profile (mm)	Length (mm)
HL4		HANDLAUF - HANDRAIL	✓	95x18	1008
HL2		HANDLAUF - HANDRAIL	✓	95x18	484
SPR1		SPARREN - RAFTERS		44x145	3104
SPR2		SPARREN - RAFTERS		44x145	2823
PF5		PFETTEN - PURLINS		44x145	5500
PF1		PFETTEN - PURLINS		44x145	5500
PF3		PFETTEN - PURLINS		44x145	5500
PF2		PFETTEN - PURLINS		44x145	2550
PF4		PFETTEN - PURLINS		44x145	2550
PF6		PFETTEN - PURLINS		44x145	2550
	DACHBRETTER - ROOF BOARDS		140+2	113x18	3769
	FUSSBODENBRETTER - FLOOR BOARDS		51+2	113x18	3529
	FUSSBODENBRETTER - FLOOR BOARDS		51	113x18	2079
	SCHLAFBODENBRETTER - SLEEPING FLOOR BOARDS		19+1	113x18	5657
	TERRASSENBRETTER (imprägniert) - TERRACE BOARDS (impregnated)		18+1	90x18	5657
	DECKENLEISTEN - CEILING STRIPS		✓	15x28	50.0 lfm/rm
	SCHLAFBODENLEISTEN - SLEEPING FLOOR STRIPS		✓	18x40	17.0 lfm/rm
	FUSSBODENLEISTEN - FLOOR STRIPS		✓	18x40	42.0 lfm/rm
A44-1	ADAPTER 44			80x120	945
TP1 20-1	STÜTZPFOSTE - SUPPORT POST 120x120		✓	120x120	2005
G02-1	GIEBELBRETTER - GABLE BOARDS 18x120	34.7° 	✓	18x120	3849
G06-1	GIEBELDECKLEISTEN - GABLE COVER STRIPS 18x58		✓	18x58	3849
T01-1	TRAUFBRETTER - EAVES BOARDS 18x95			18x95	3925
T06-1	TRAUFBREITENLEISTEN - EAVES STRIPS 18x40		✓	18x40	16.0 lfm/rm
TR02	LEITER - LADDER 2600mm				
Kood	Nice 6x6 Lux Mezzanine 595x595_44		Materjal	Leht 5/13	

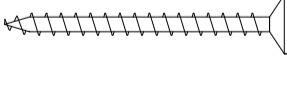
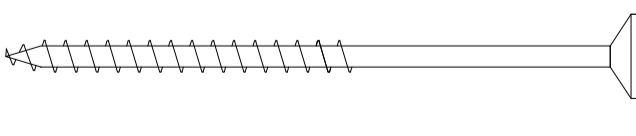
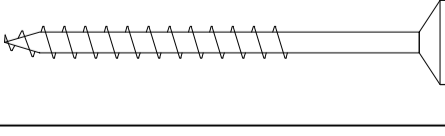
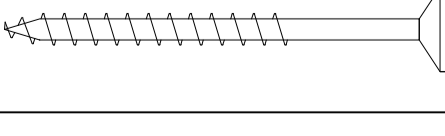
Pos	Teileliste/Specification Nice 6x6 Lux Mezzanine 595x595_44		Pcs.	Profile (mm)	Length (mm)
SH	SCHLAGHÖLZER - MOUNTING PIECES		3		
GS	GIEBELSEGMENT - GABLE DIAMOND		2		
HK2	HOLZ-KLOTZEN für verbinden der Wandbohlen - Wooden wedge for connecting the wall parts (122mm)		2		
NG2 550	NÄGEL - NAILS 2.5x50 Dachbretter - Roof boards		1680		
NG2 550	NÄGEL - NAILS 2.5x50 Fussbodenbretter - Floor boards		1224		
NG2 550	NÄGEL - NAILS 2.5x50 Terrassenbretter - Terrace boards		450		
BFP	Befestigungsplatten für Sparren - Mounting plate for rafters		2		
SS413	Sechskantschrauben - Hex bolts M10x80 Mutter - Nut M10 U-Scheibe - Washer Ø30 (für Sparren - for rafters)		2		
SS1216	Schloßschrauben - Wood bolts M12x160 für Sparren - for rafters		4		
MUT21	Mutter - Nut M12 für Sparren - for rafters		4		
US05	U-Scheibe - Washer M12 Ø40 für Sparren - for rafters		4		
VS	Verbindungsstreifen für verbinden der Wandbohlen - Connecting strip for connecting the wall parts		2		
VP3	Verstellbare Pfostenstütze - Adjustable post support M20		2		
SR3 030	Schrauben - Screws 3.0x30 Deckenleisten - Ceiling strips		88		
SR3 030	Schrauben - Screws 3.0x30 Fussbodenleisten - Floor strips		77		
SR3 030	Schrauben - Screws 3.0x30 Traufenleisten - Eaves strips		32		
SR3 545	Schrauben - Screws 3.5x45 Giebelbretter - Gable boards		32		
SR3 545	Schrauben - Screws 3.5x45 Giebeldeckleisten - Gable cover strips		32		
SR3 545	Schrauben - Screws 3.5x45 Giebelsegment - Gable diamond		4		
SR3 545	Schrauben - Screws 3.5x45 Handlauf - Handrail		23		
SR3 545	Schrauben - Screws 3.5x45 Traufenbretter - Eaves boards		32		
SR354 5-001	Schrauben - Screws 3.5x45 Verbindungsstreifen - Connecting strip		8		
SR5 0100	Schrauben - Screws 5.0x100 Fundamenthölzer - Foundation beams		148		
SR5 070	Schrauben - Screws 5.0x70 Stützpfole - Support post		4		
SR507 0-002	Schrauben - Screws 5.0x70 Verstellbare pfostenstütze - Post support		16		
Kood	Nice 6x6 Lux Mezzanine 595x595_44		Materjal		Leht 6/13















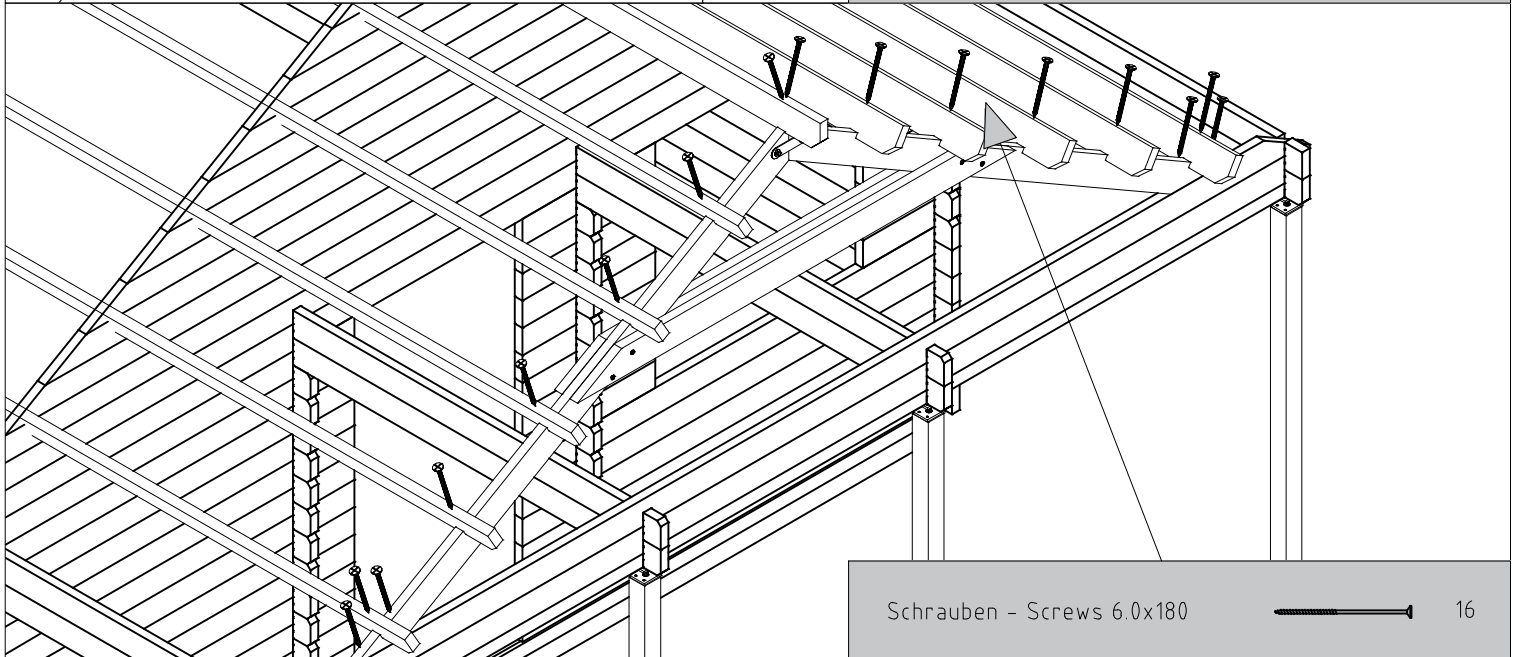
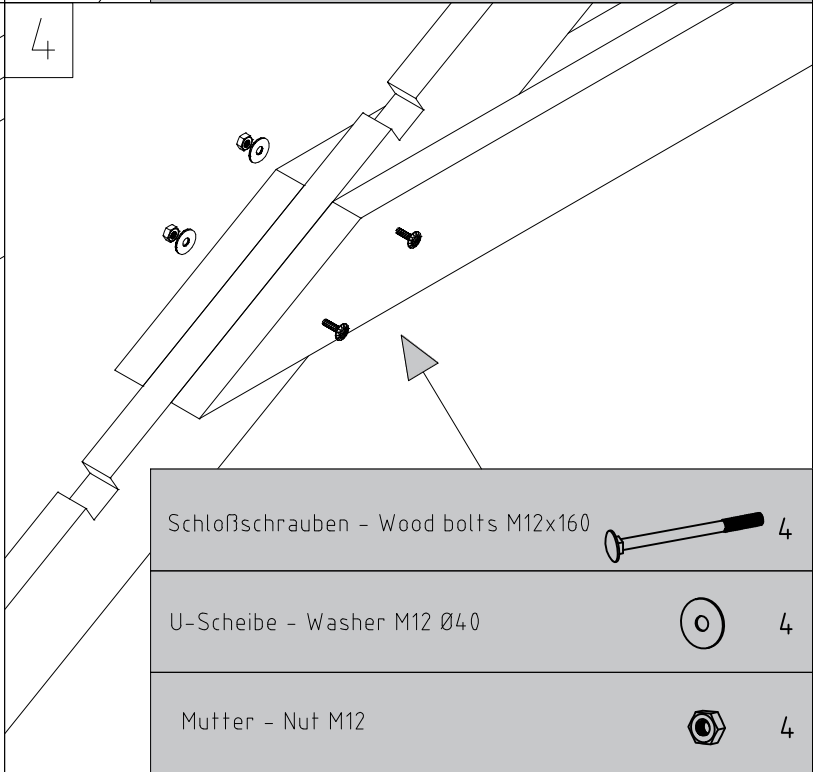
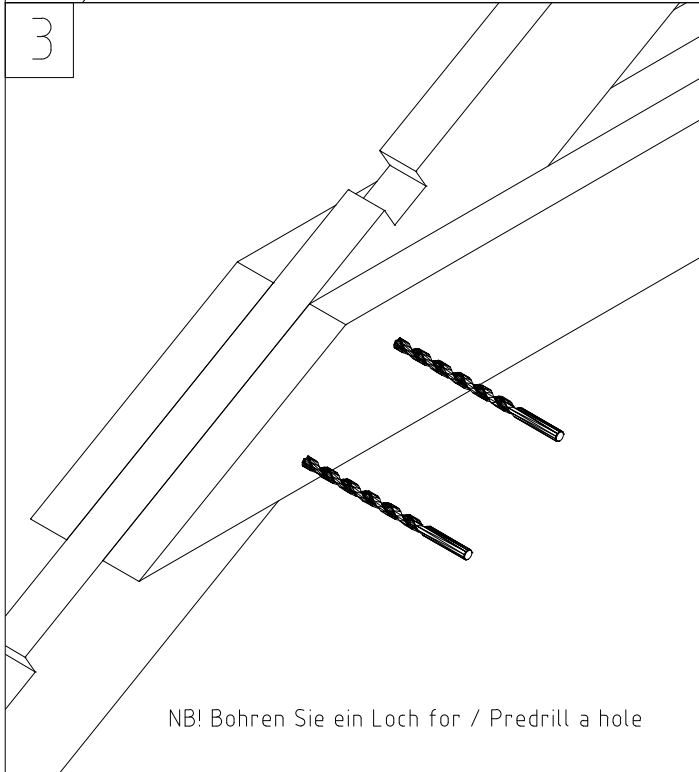
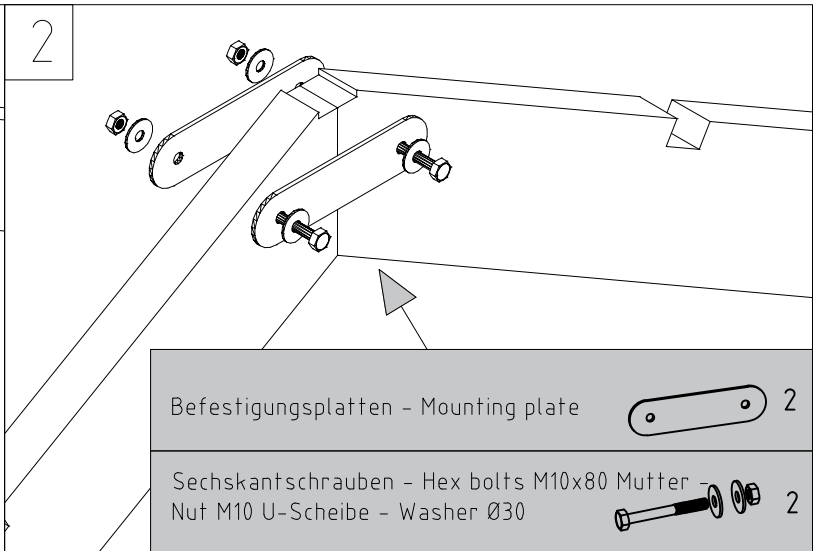
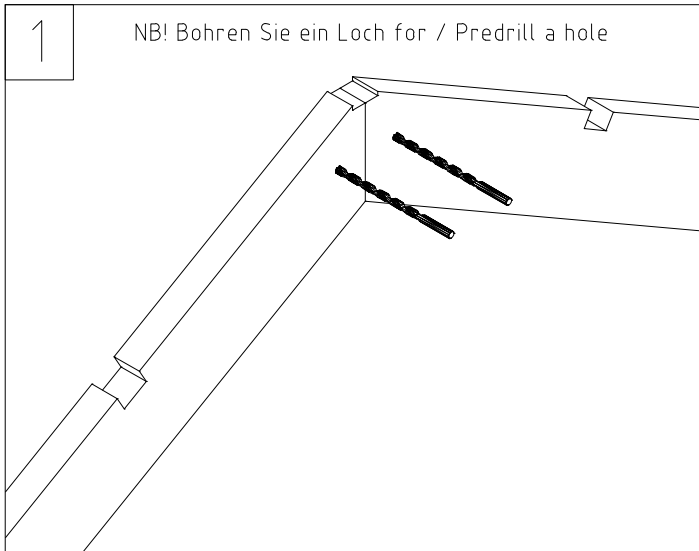

## Vihmaliist / Rain strip / Wasserleiste

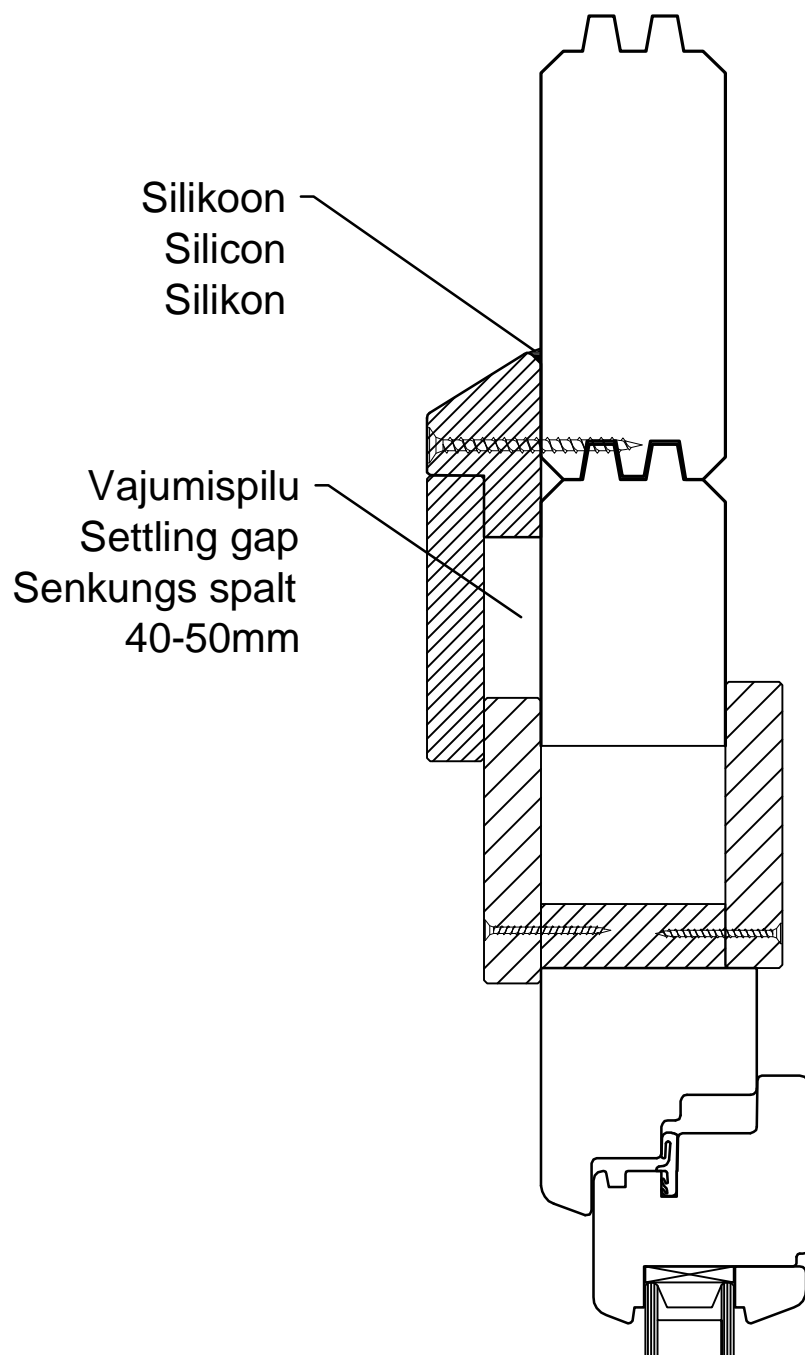

NB!

- Monteerida juhul kui ese on välja toodud maja spetsifikatsioonis!
- Install only if the item is listed in the house specification!
- Nur montieren wenn die Leiste in der Teileliste gezeigt ist!

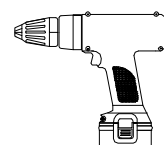

Window assembly  
Fenster montage  
Ensemble de fenetre

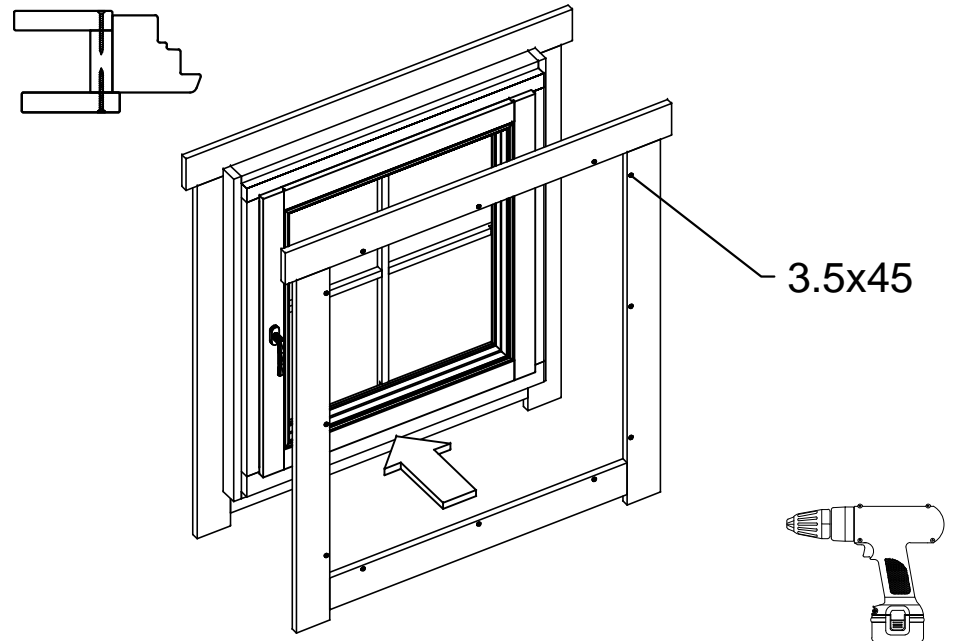
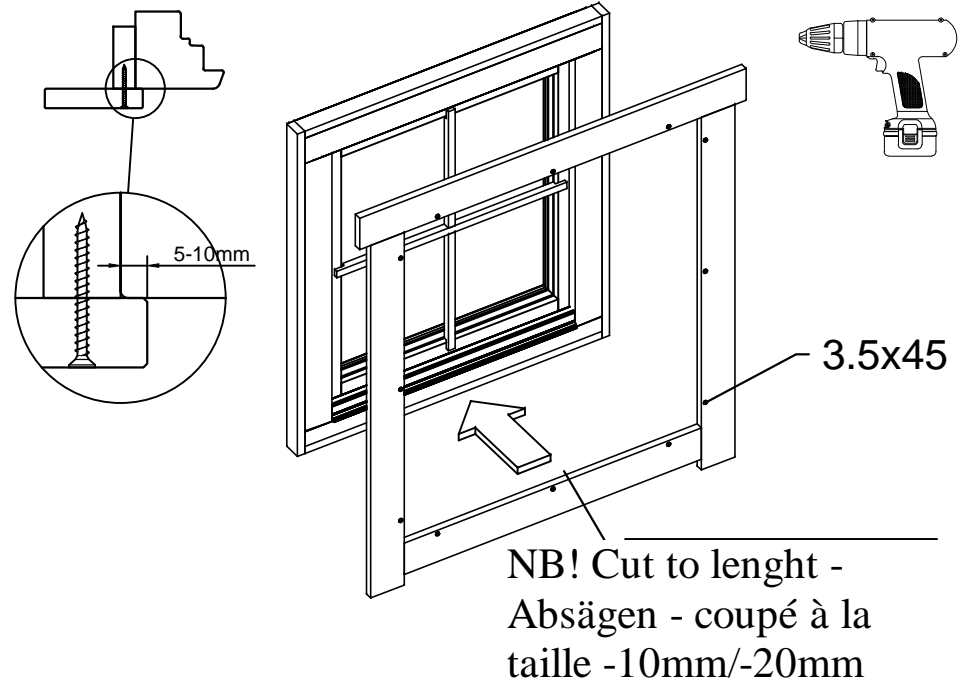
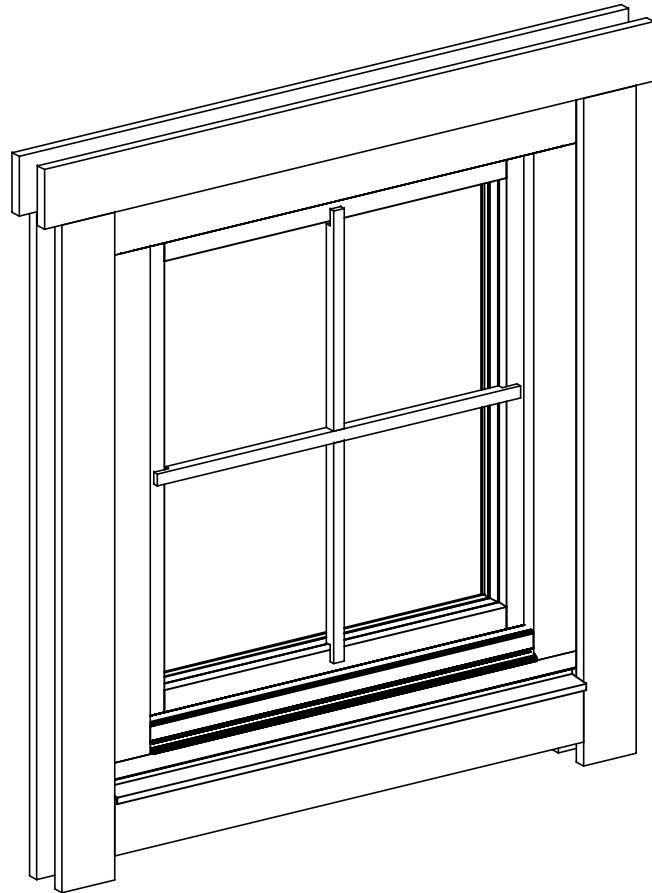

Ukse montaa 0 / Tür montage / Door assembly  
(GH+ / SH)

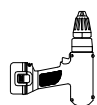
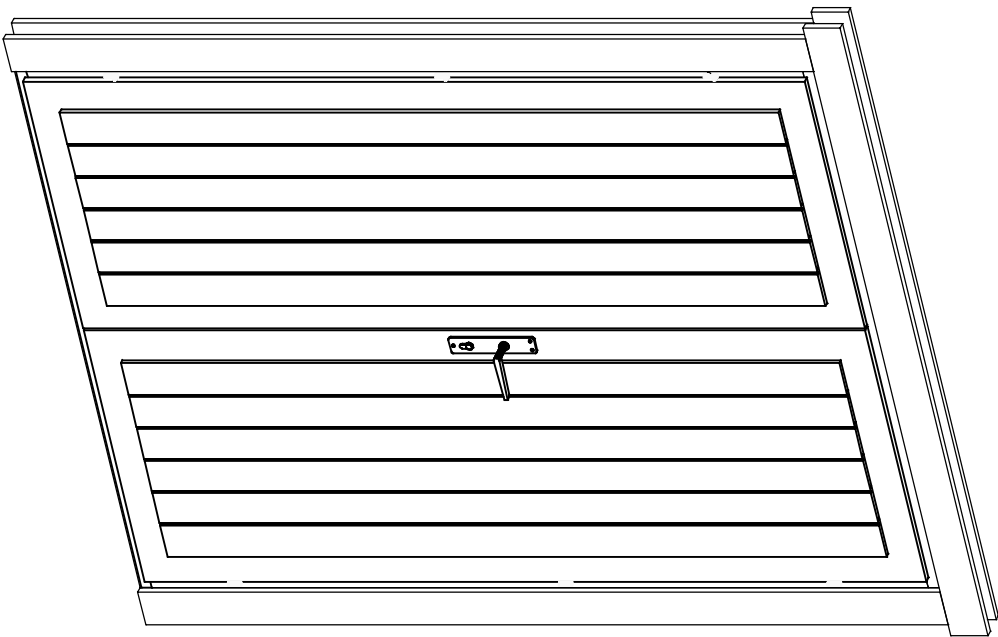

4.5x90

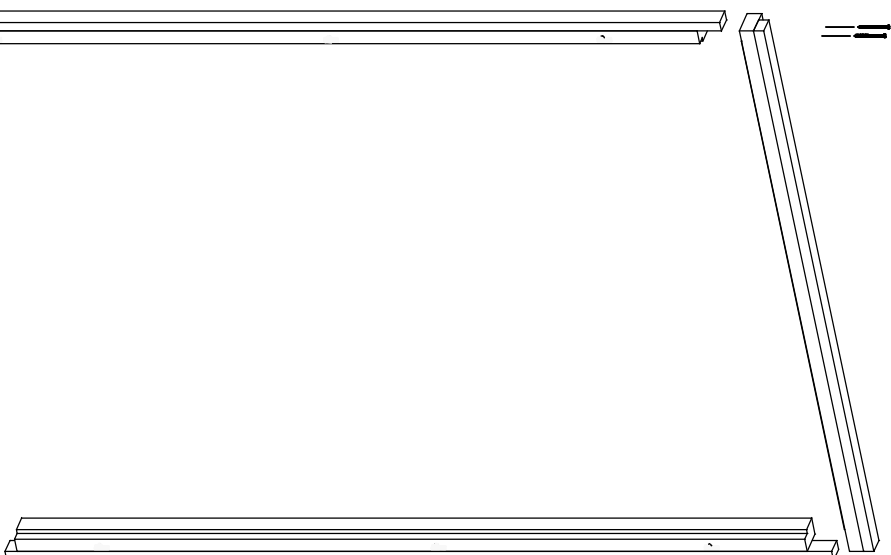

4.5x90



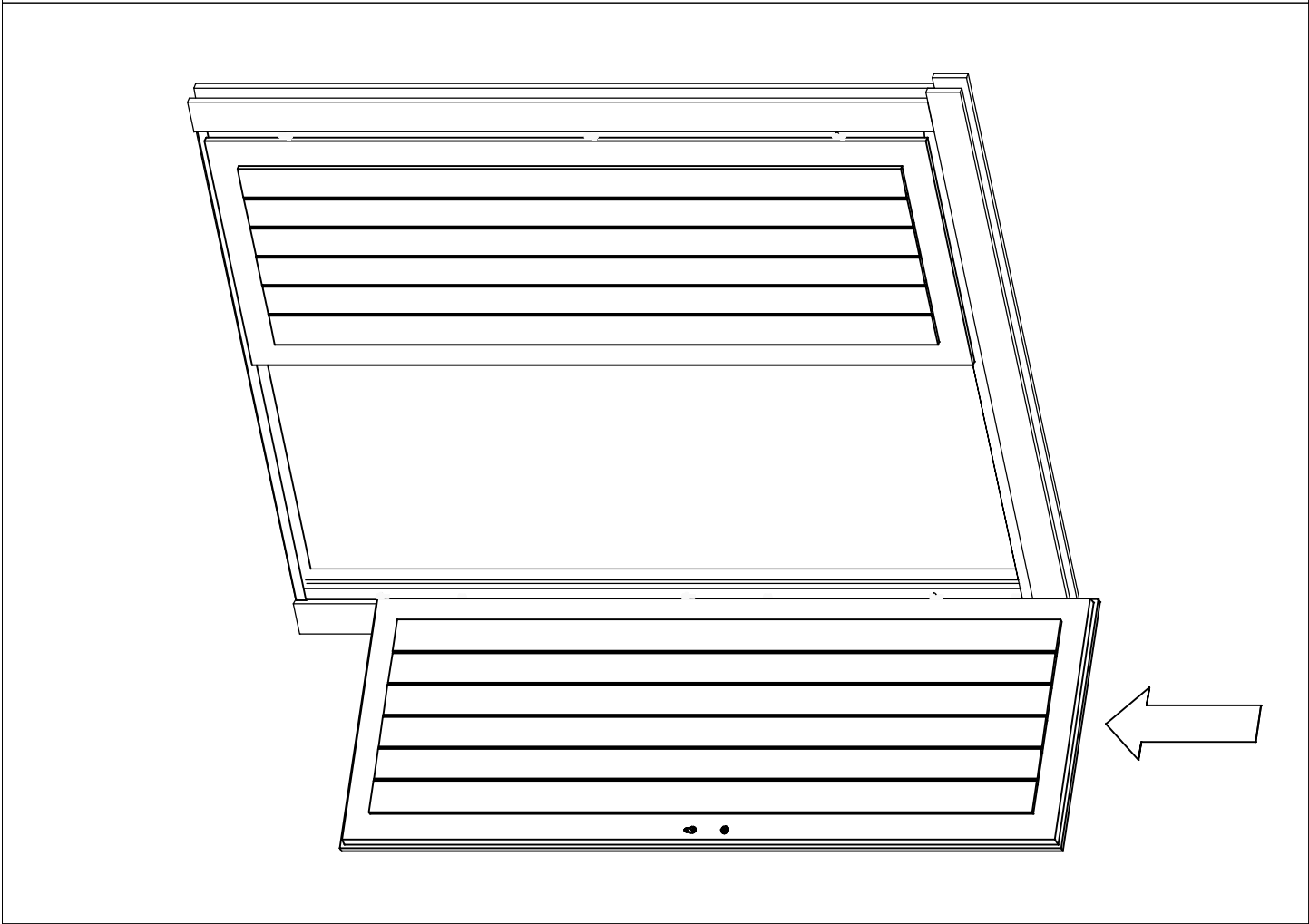
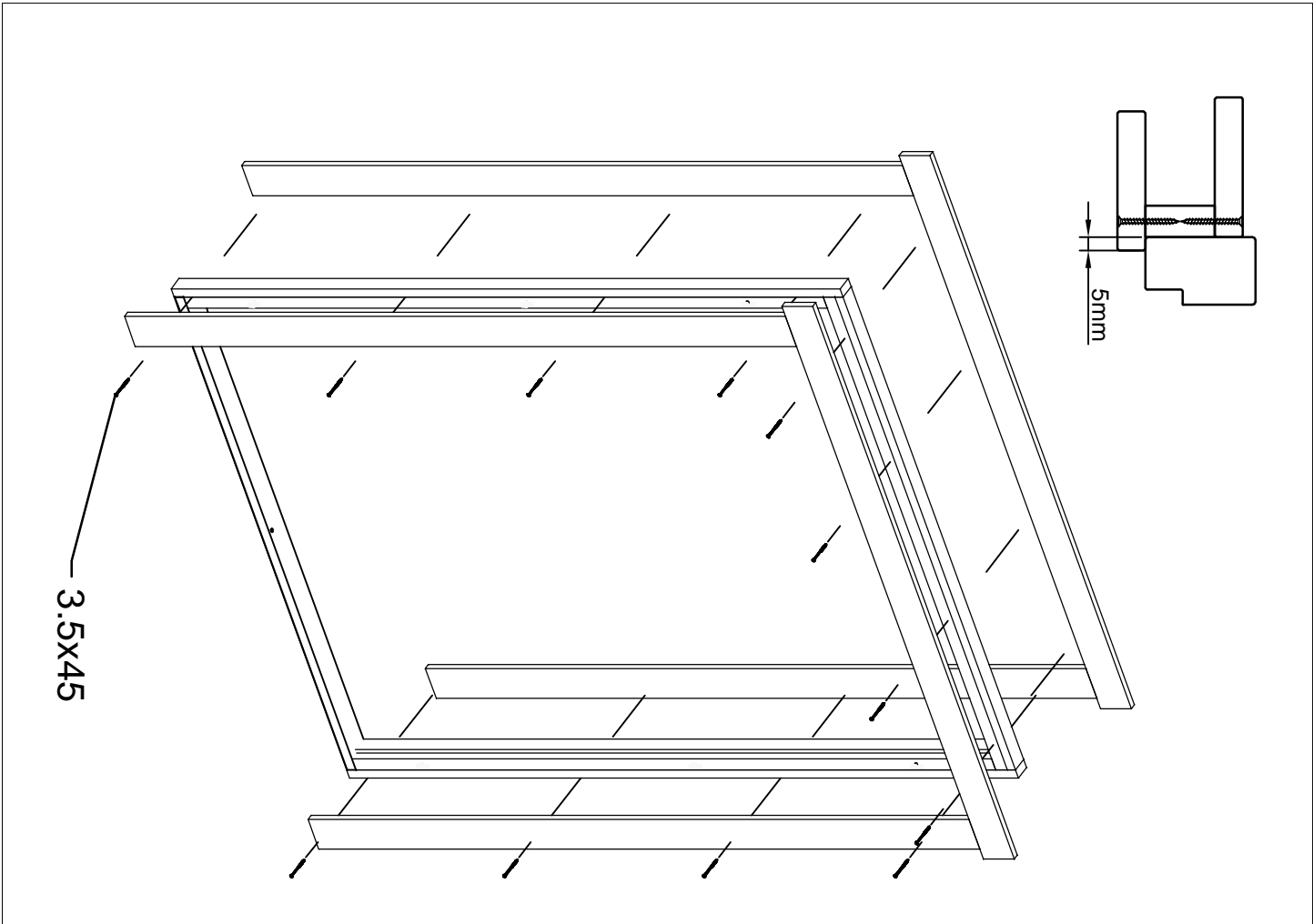

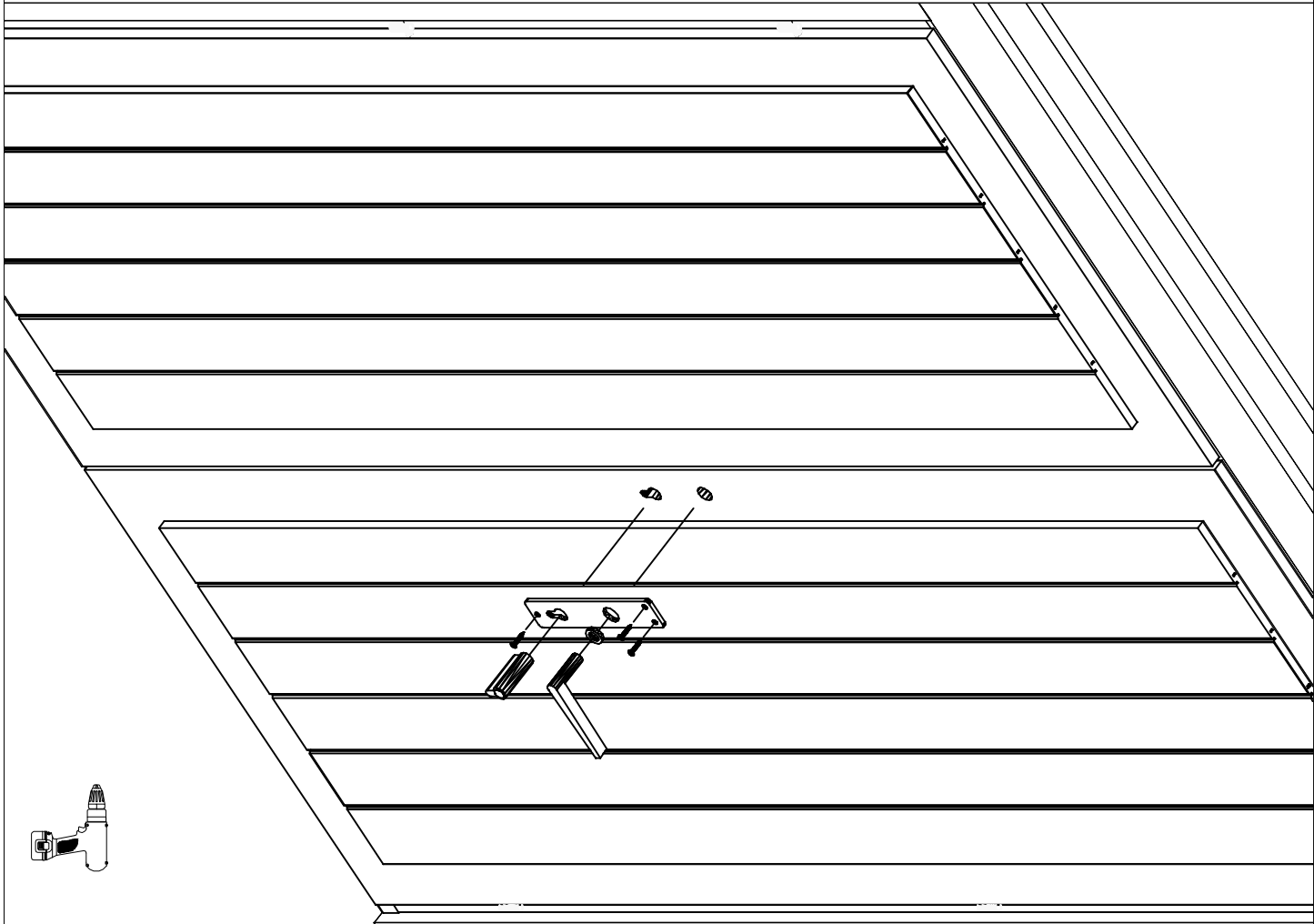
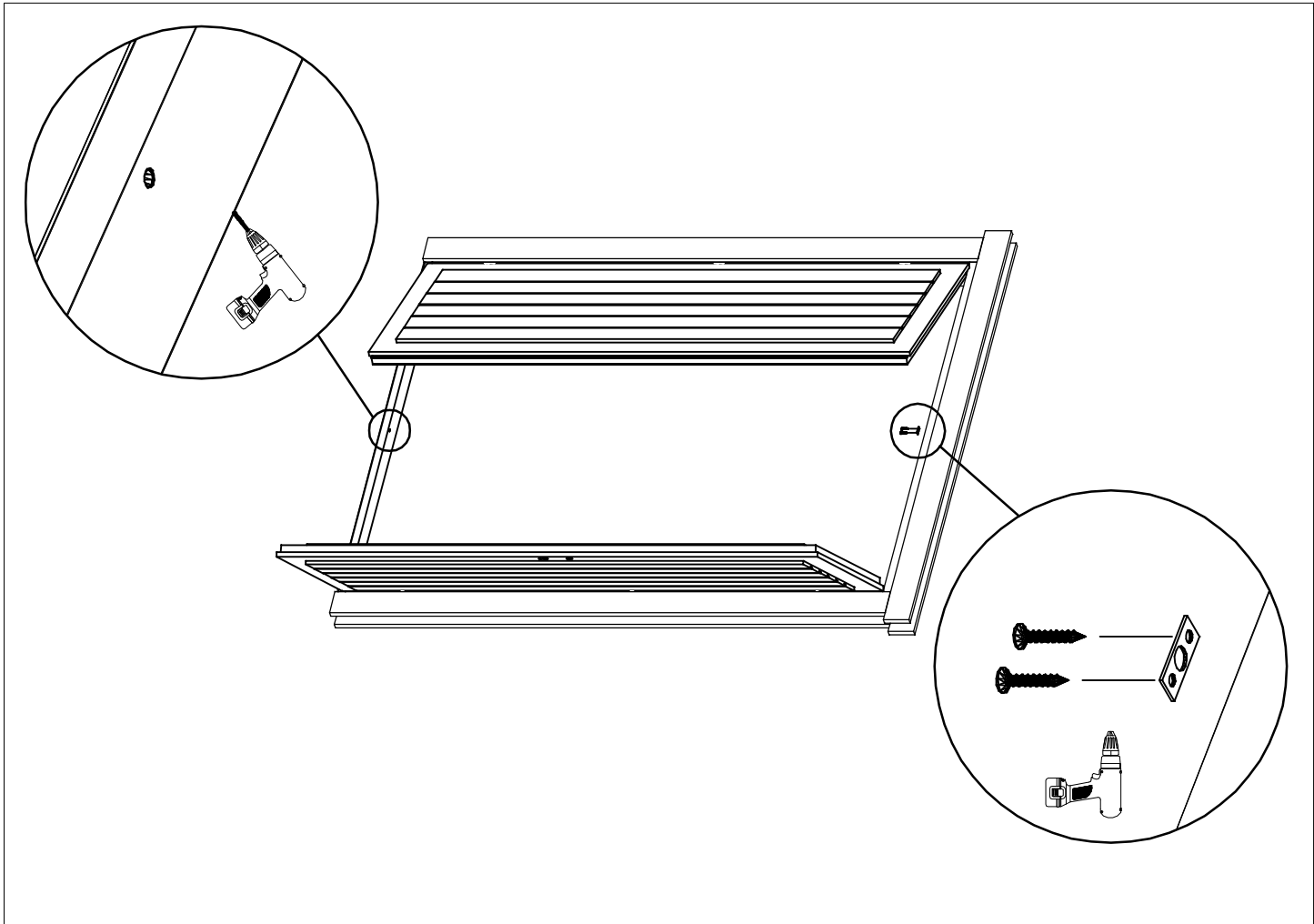

- Giebeldeckleisten  
Gable cover strips
- Dachbretter  
Roof boards 18x113
- Giebelbretter  
Gable boards
- Pfetten/Wandbohlen  
Purlins/Wall log

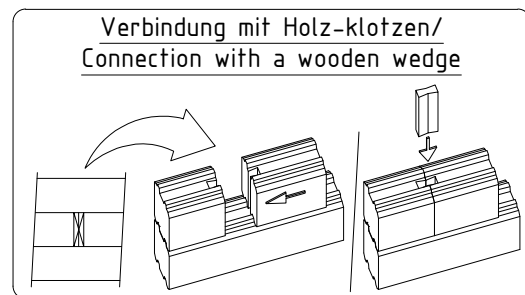
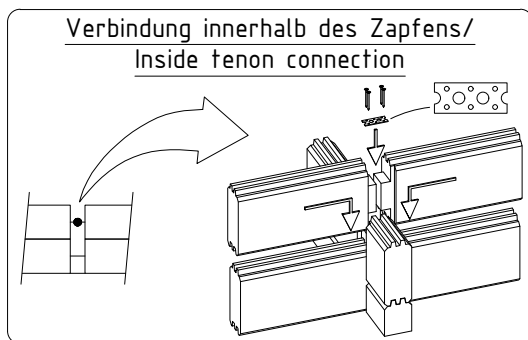
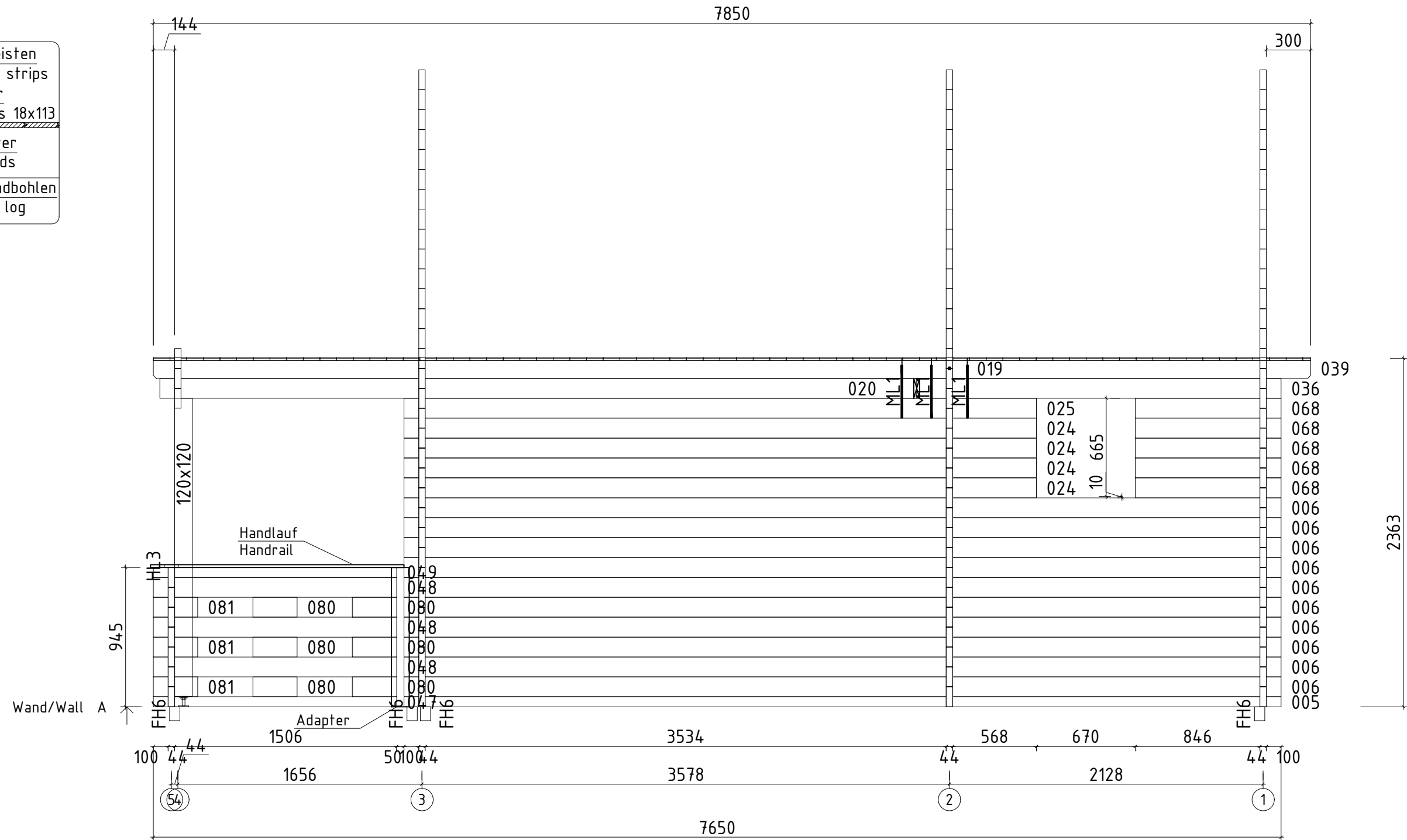

Name	Nice 6x6 Lux Mezzanine 595x595_44		
Zeichnung/Drawing	WAND/WALL A	VS44_NICE6x6LUXMEZ	
Profil/Profile	4.4x13.5	Maßstab/Scale	1:30
		Druck auf/ Print on	A3
		Datum/Date	18.05.2026

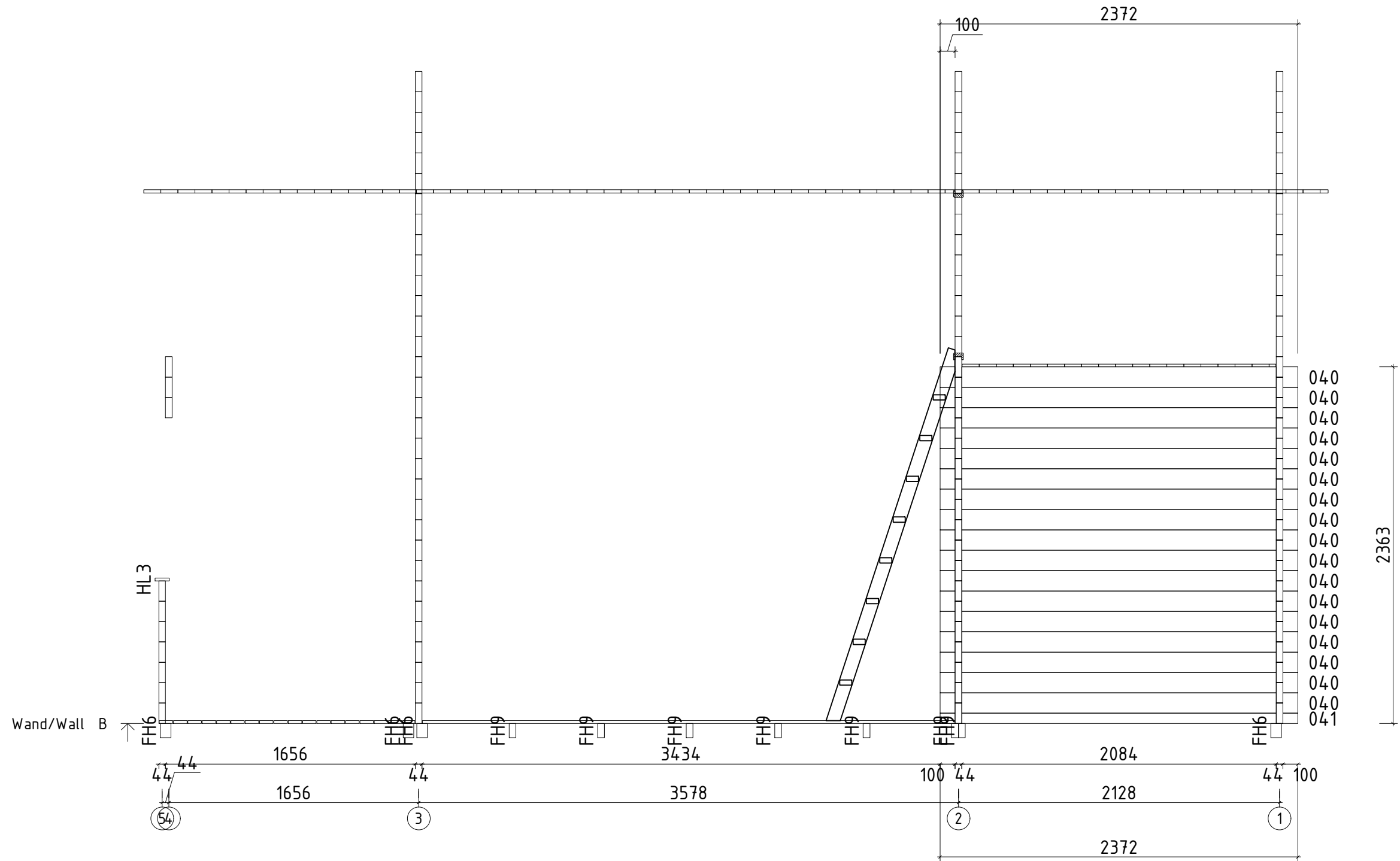

Name	Nice 6x6 Lux Mezzanine 595x595_44		
Zeichnung/Drawing	WAND/WALL B	VS44_NICE6x6LUXMEZ	
Profil/Profile	4.4x13.5	Maßstab/Scale	1:30
		Druck auf/Print on	A3
		Datum/Date	18.05.2026

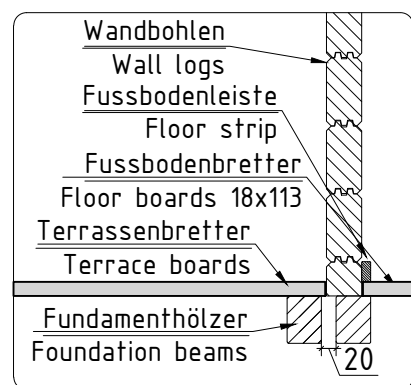
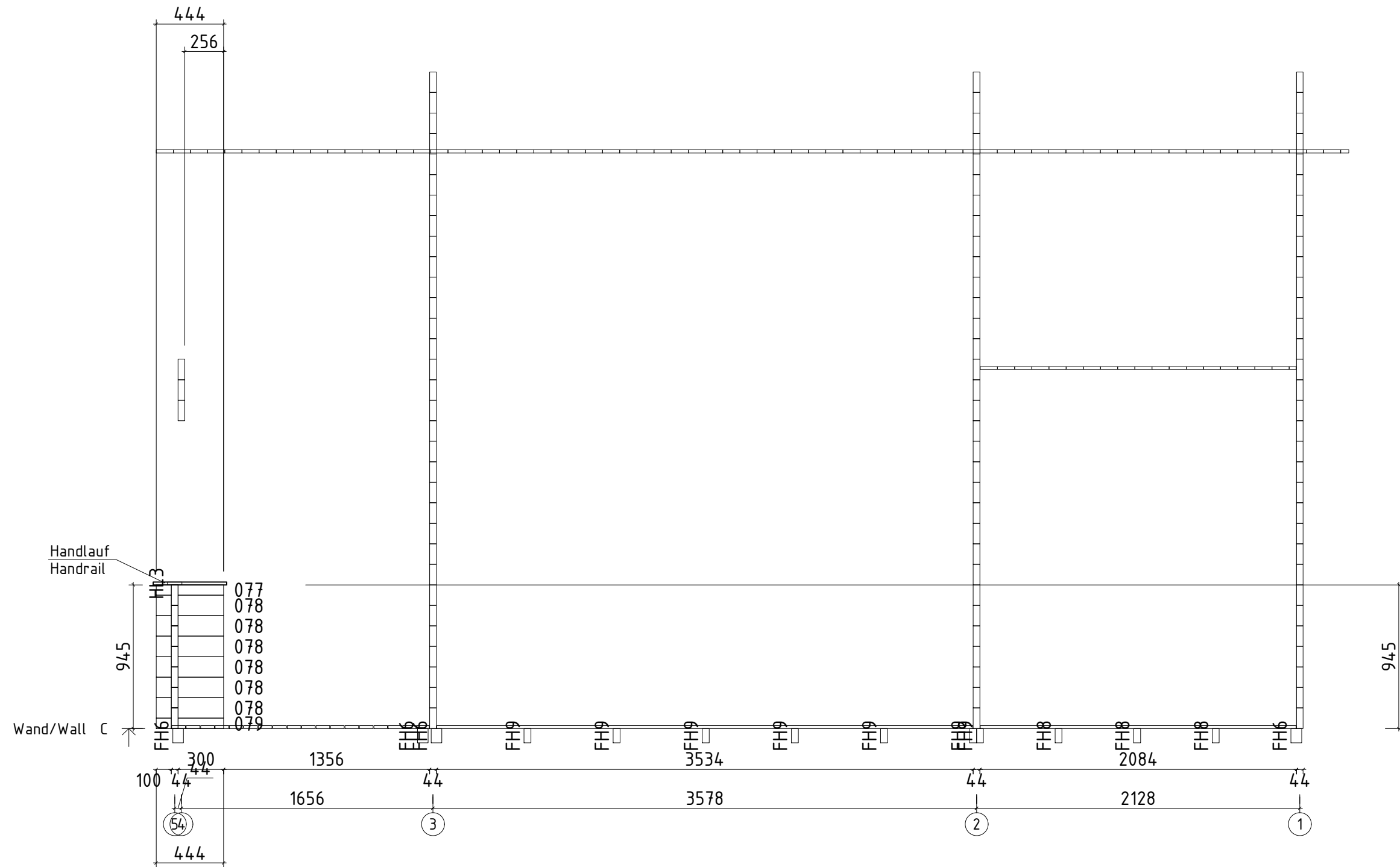

Name	Nice 6x6 Lux Mezzanine 595x595_44		
Zeichnung/Drawing	WAND/WALL C	VS44_NICE6x6LUXMEZ	
Profil/Profile	4.4x13.5	Maßstab/Scale	1:30
		Druck auf/ Print on	A3
		Datum/Date	18.05.2026

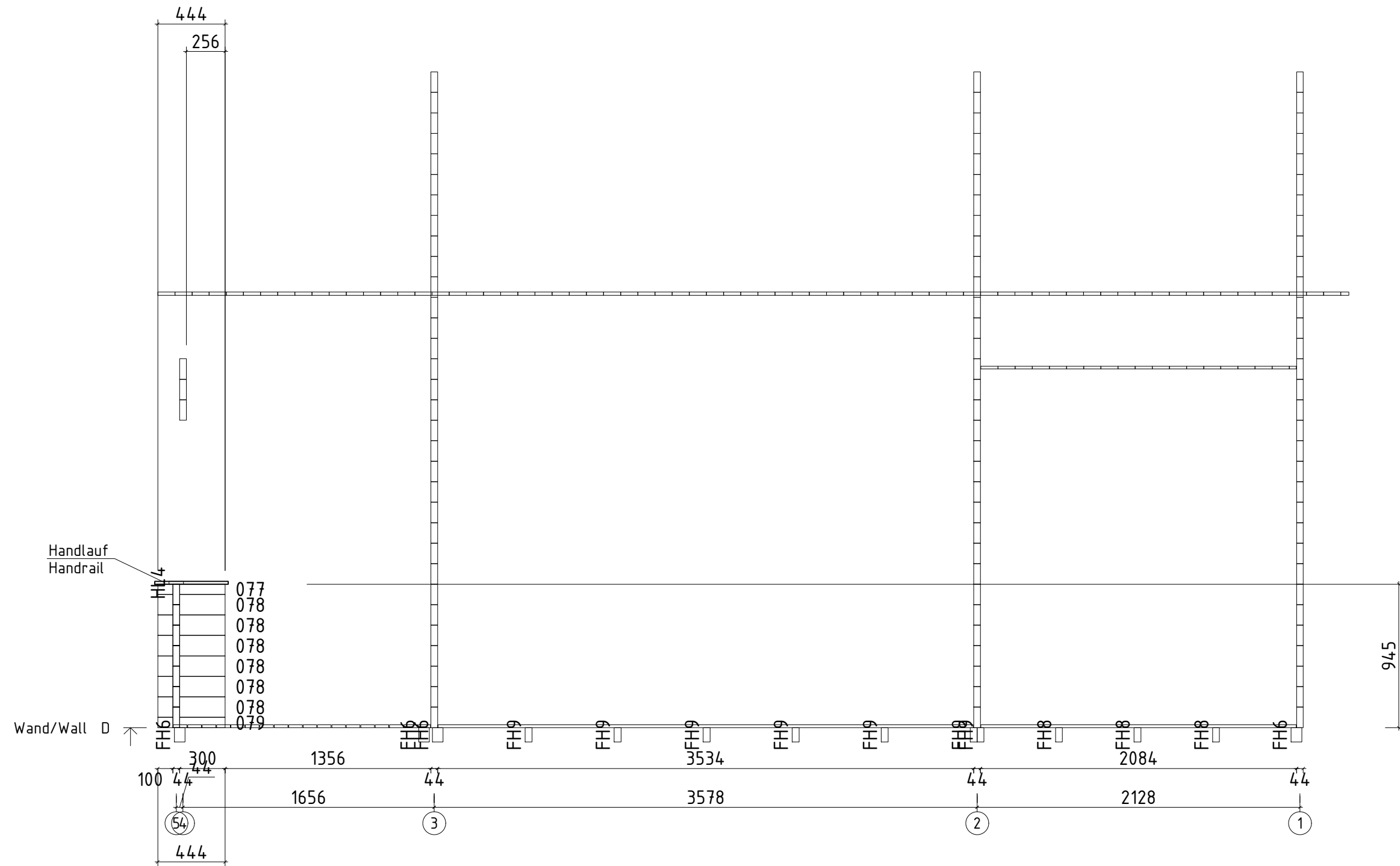

Name		Nice 6x6 Lux Mezzanine 595x595_44	
Zeichnung/Drawing		WAND/WALL D	VS44_NICE6x6LUXMEZ
Profil/Profile	4.4x13.5	Maßstab/Scale	1:30
Druck auf/Print on	A3	Datum/Date	18.05.2026

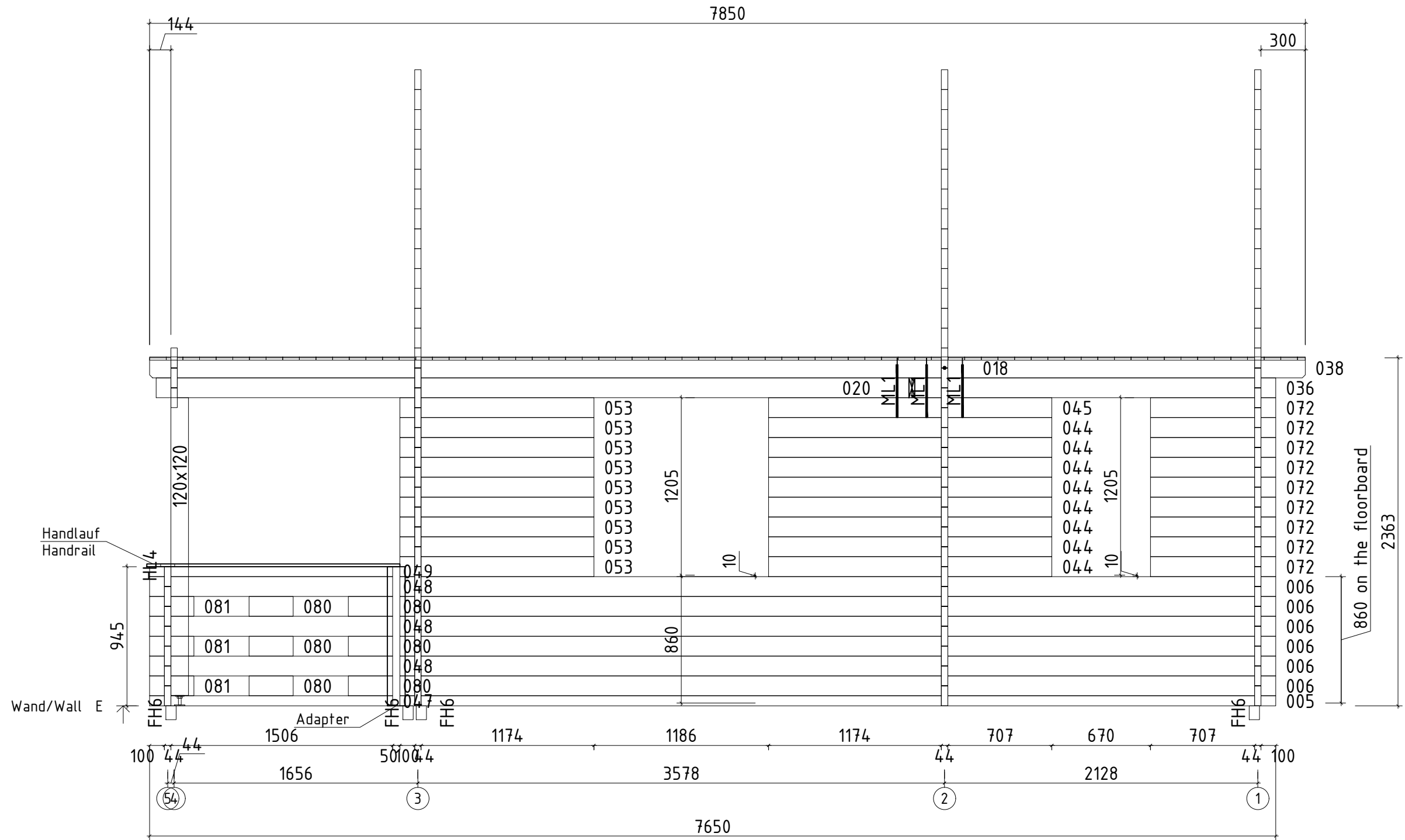

Name		Nice 6x6 Lux Mezzanine 595x595_44	
Zeichnung/Drawing		WAND/WALL E	VS44_NICE6x6LUXMEZ
Profil/Profile	4.4x13.5	Maßstab/Scale	1:30
Druck auf/Print on	A3	Datum/Date	18.05.2026







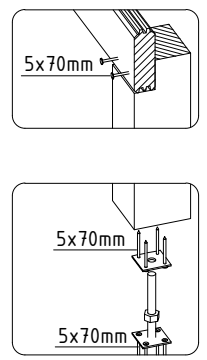
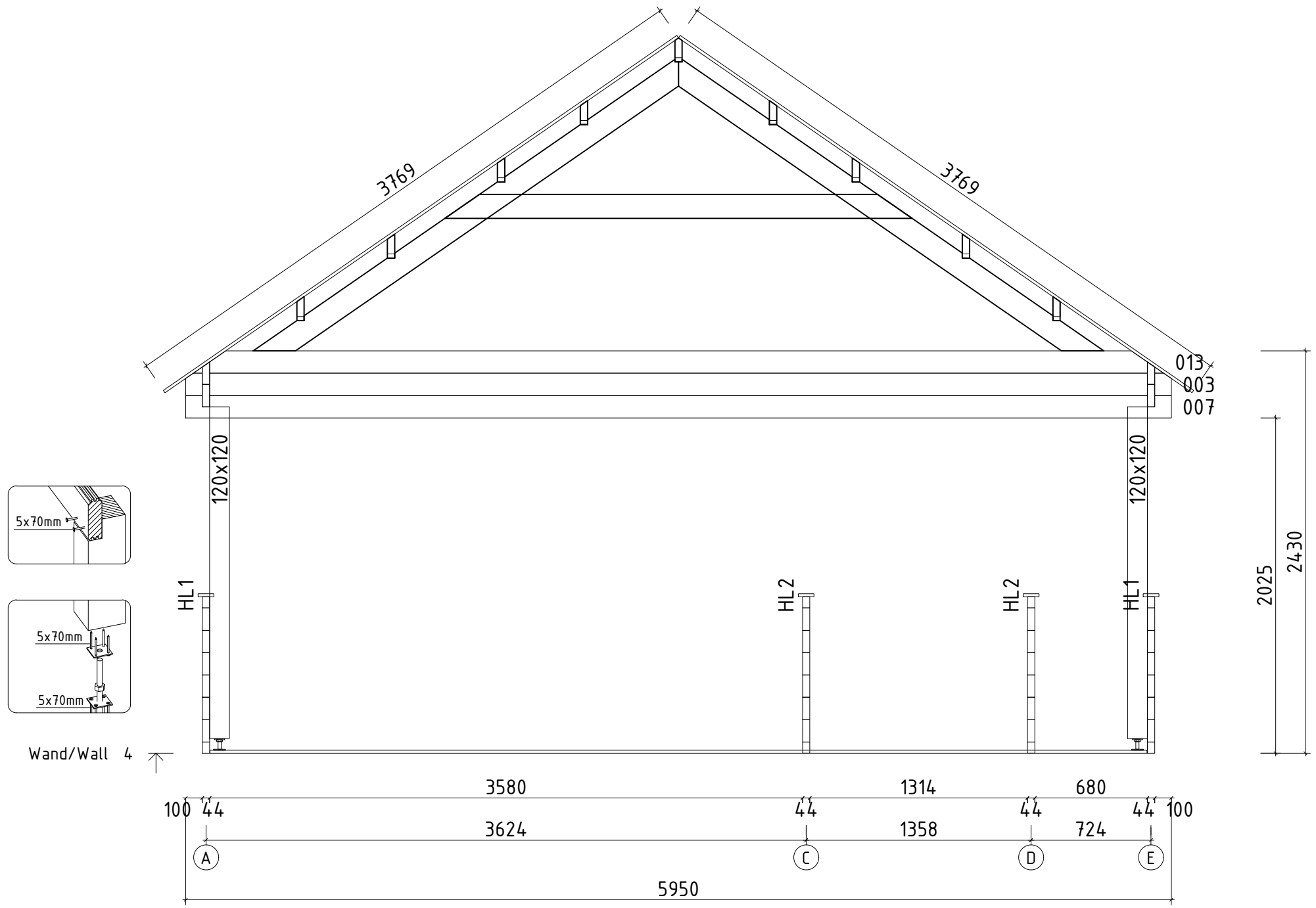

Wand/Wall 4

Name	Nice 6x6 Lux Mezzanine 595x595_44		
Zeichnung/Drawing	WAND/WALL 4	VS44_NICE6x6LUXMEZ	
Profil/Profile	4.4x13.5	Maßstab/Scale	1:30
		Druck auf/Print on	A3
		Datum/Date	18.05.2026

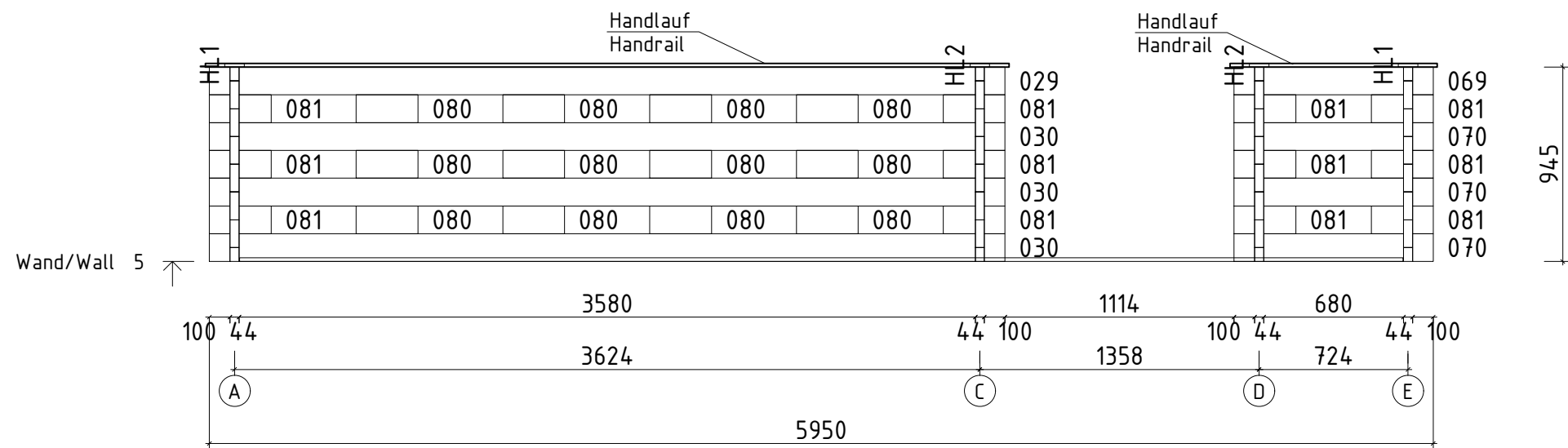
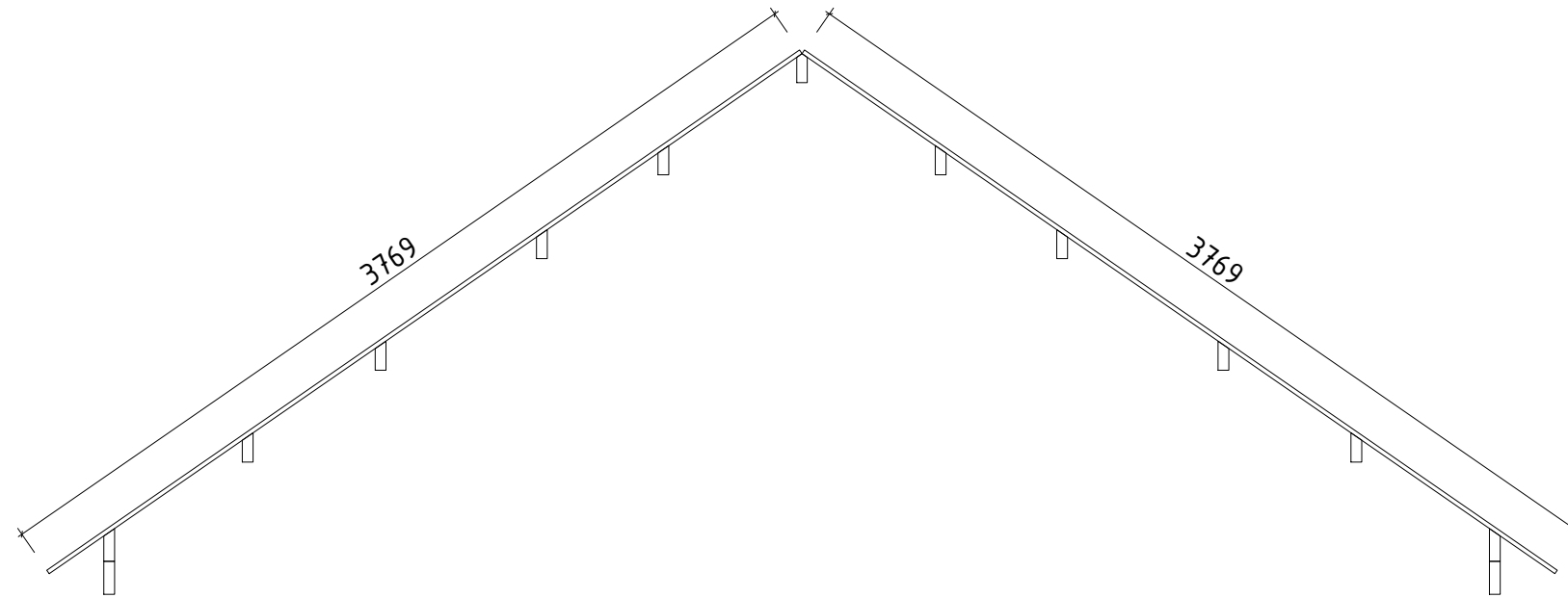

Name		Nice 6x6 Lux Mezzanine 595x595_44	
Zeichnung/Drawing		WAND/WALL 5	VS44_NICE6x6LUXMEZ
Profil/Profile	4.4x13.5	Maßstab/Scale	1:30
Druck auf/ Print on	A3	Datum/Date	18.05.2026