

Name	Lord 5x7 MAX + BALKONY 500x700+VD_ 44		
Zeichnung/Drawing	3D	VS44_LORDMAXBALCONY	
Profil/Profile	4.4x13.5	Maßstab/Scale	1:30
		Druck auf/ Print on	A3
		Datum/Date	31.03.2026

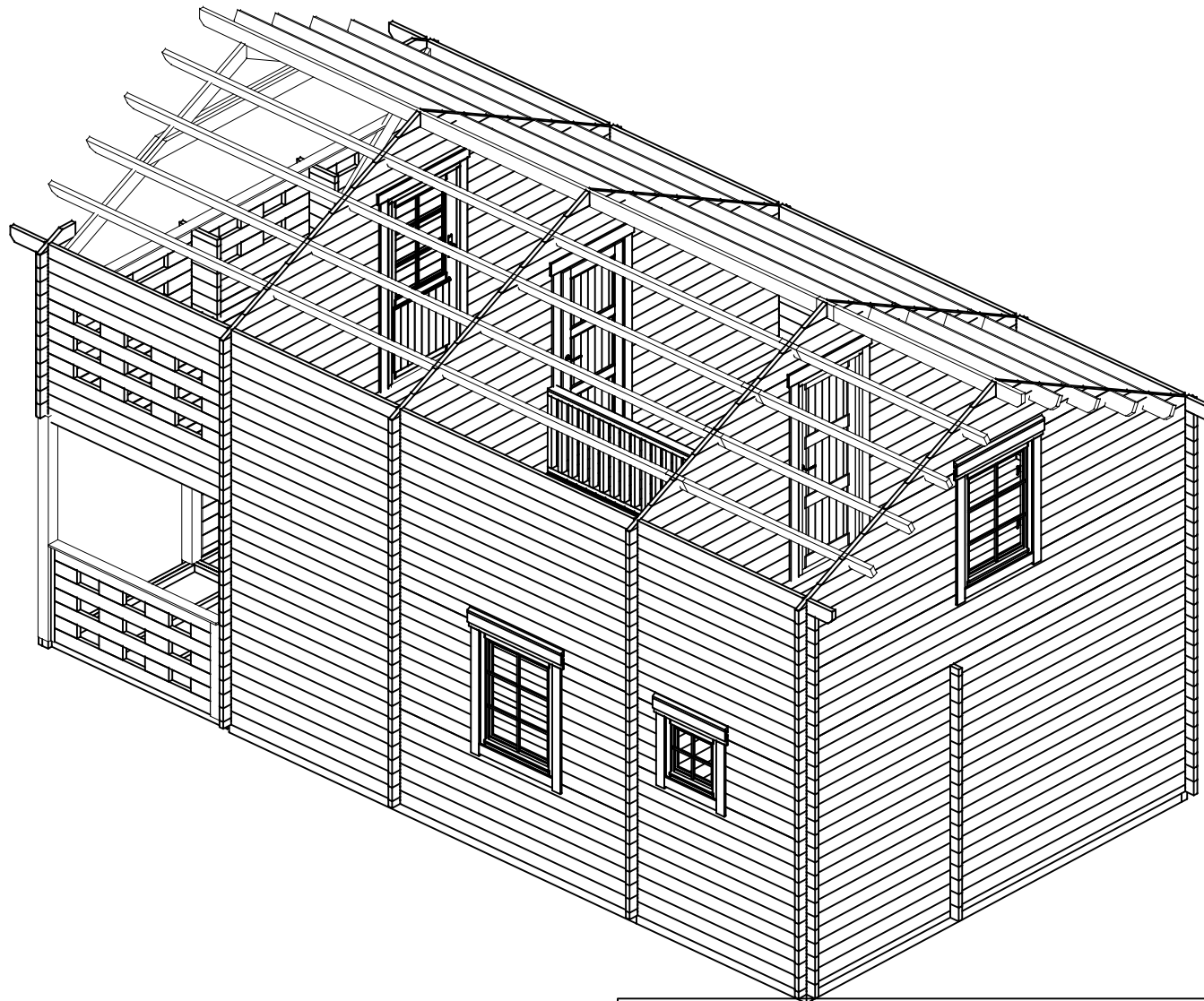

Name	Lord 5x7 MAX + BALKONY 500x700+VD_ 44		
Zeichnung/Drawing	3D	VS44_LORDMAXBALCONY	
Profil/Profile	4.4x13.5	Maßstab/Scale	1:30
		Druck auf/ Print on	A3
		Datum/Date	31.03.2026

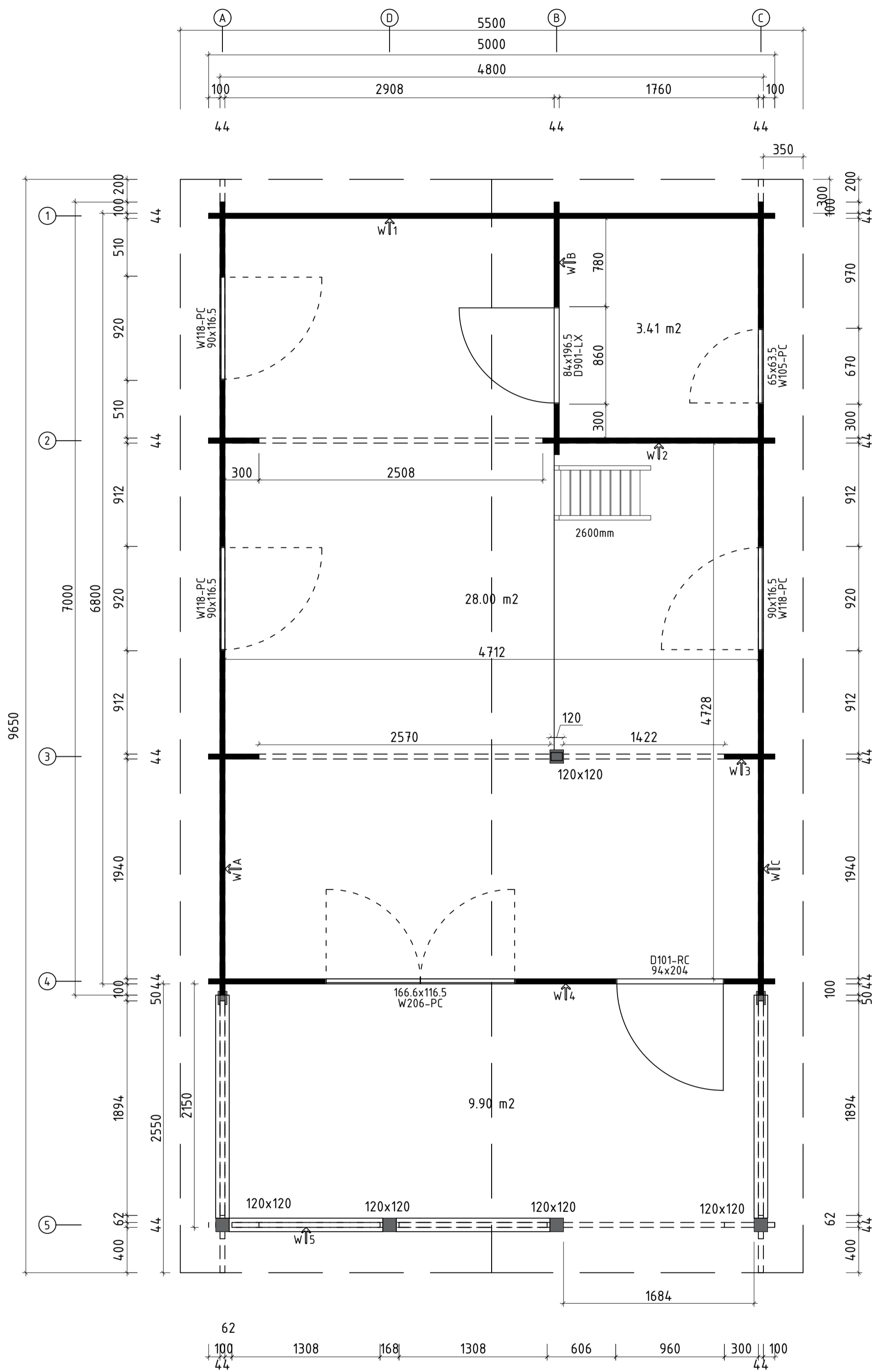

Q3- Qualitätsklasse für Fenster und Türen/
Quality class for windows and doors
* Fenster und Türen sind mit Sprossen/
Windows and doors are with muntins

Name	Lord 5x7 MAX + BALKONY 500x700+VD_44		
Zeichnung/Druck	Grundplan - 1st Floor plan	V\$44	LORDMAXBALKONY
Profil/Profile	4.4x13.5	Maßstab/Scale	1:30
	Druck auf/Print on	A2	Datum/Date
			31.03.2026

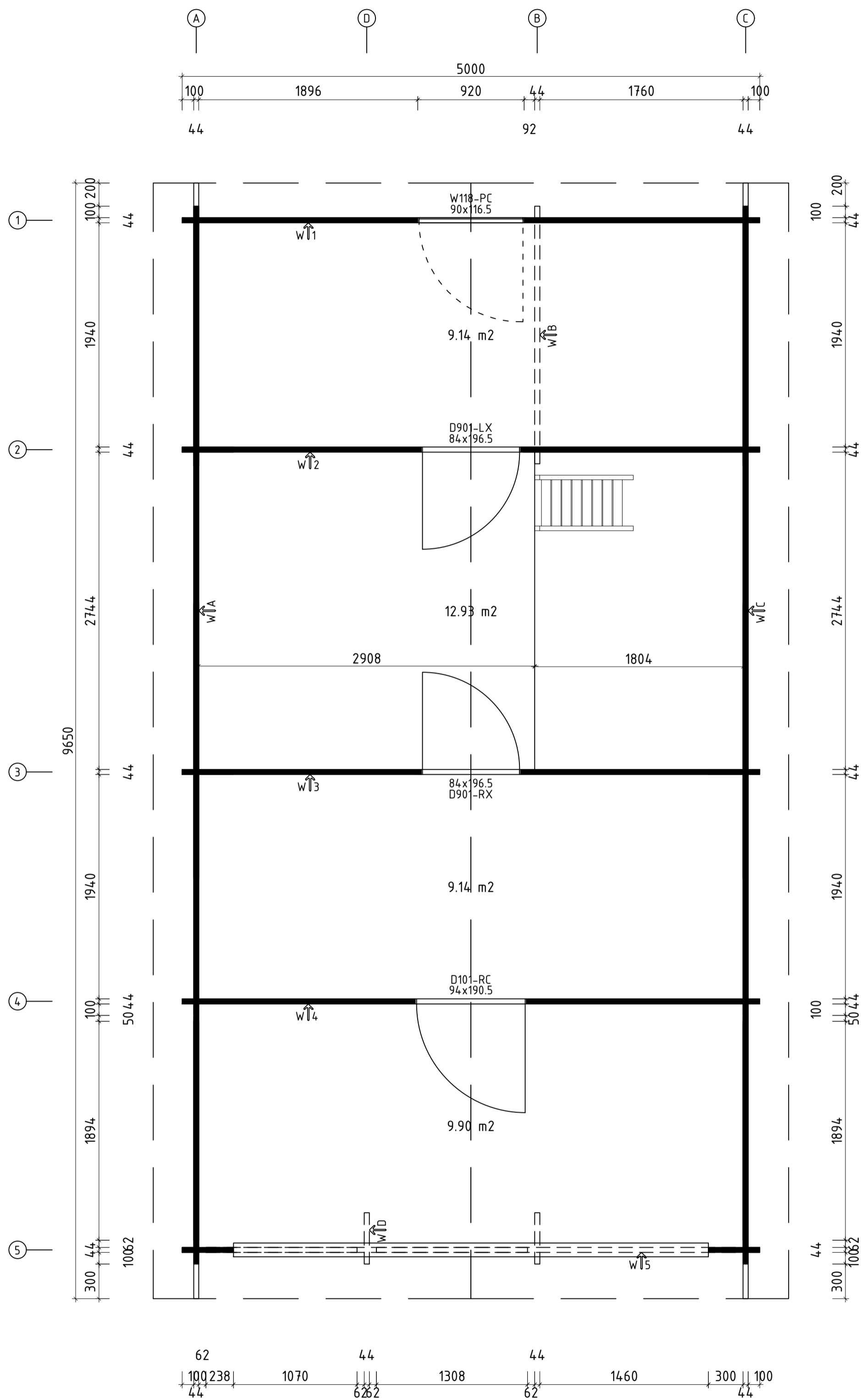

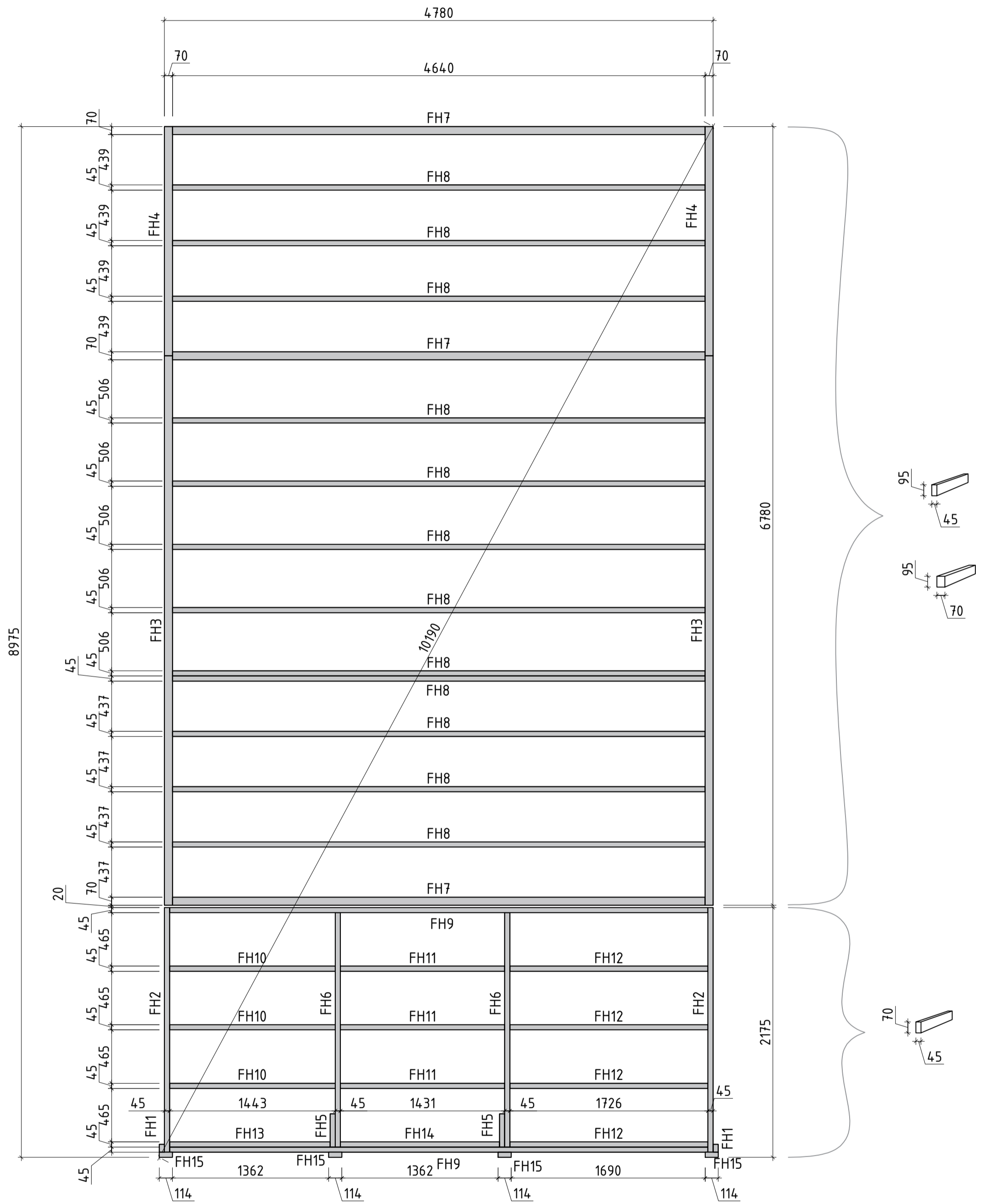

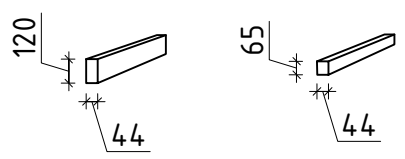
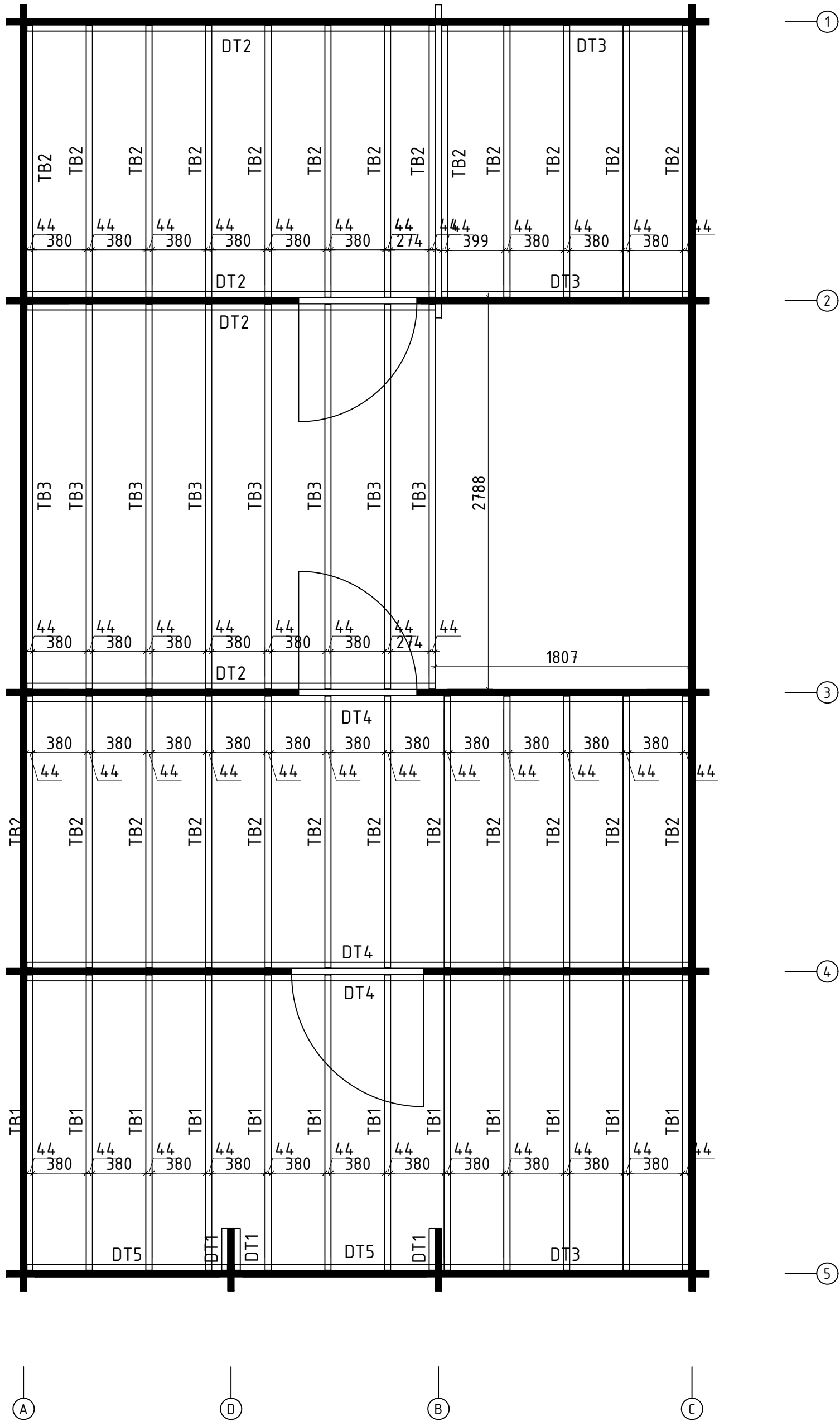



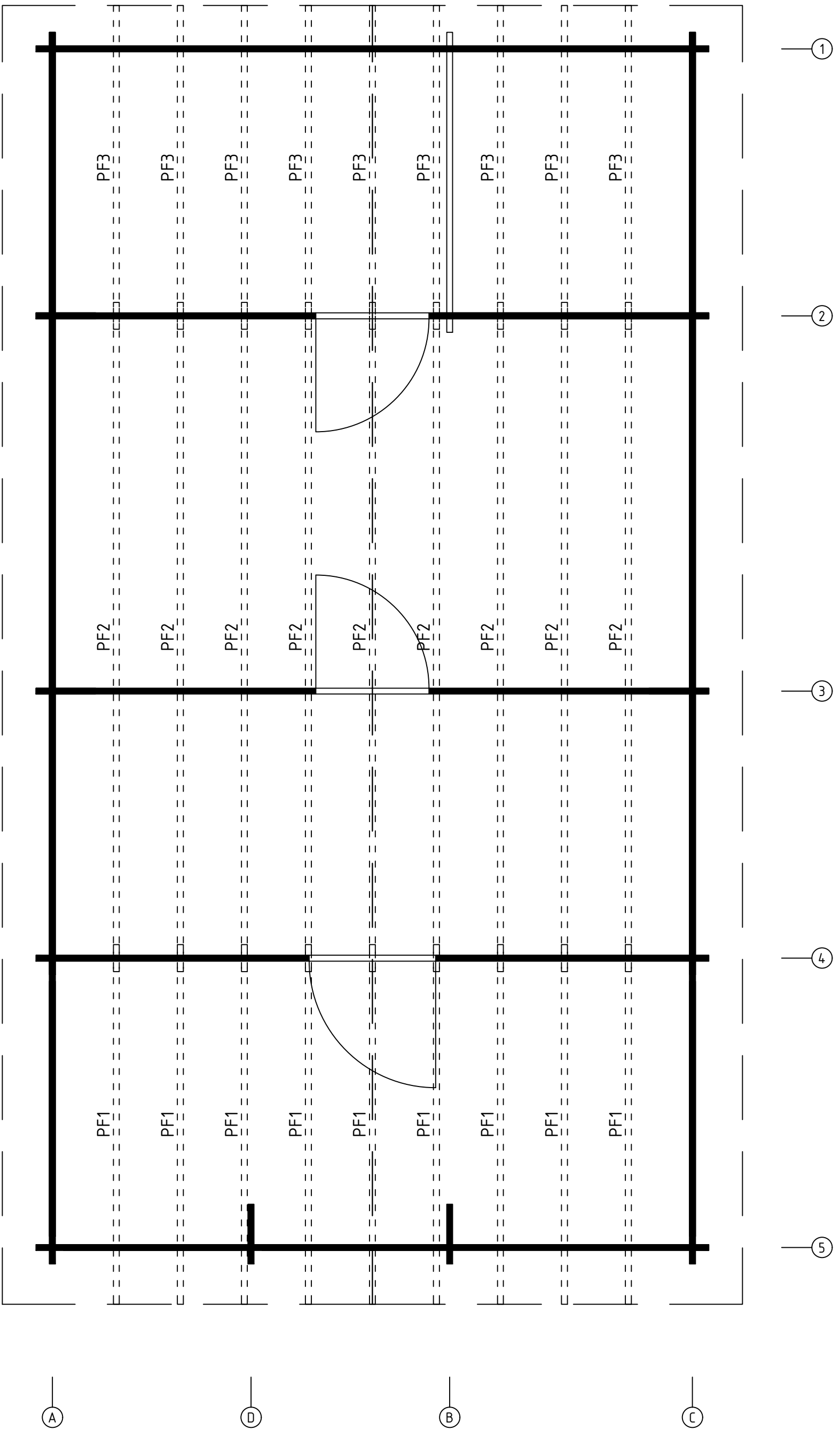



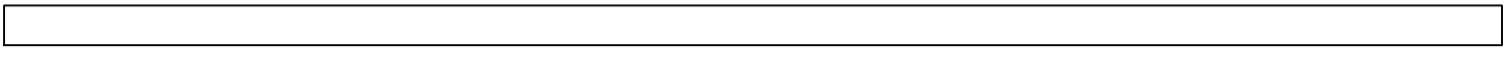
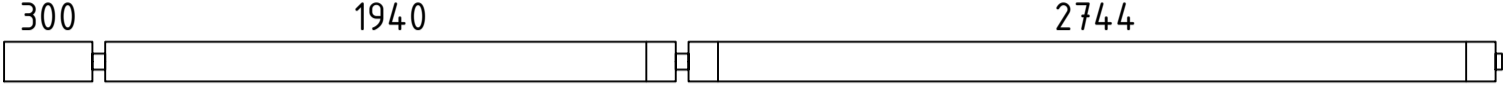
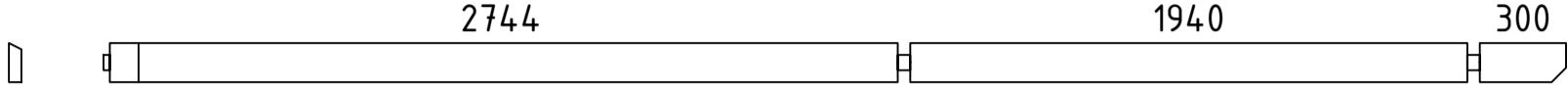
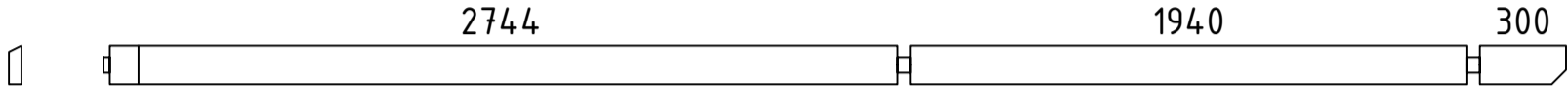
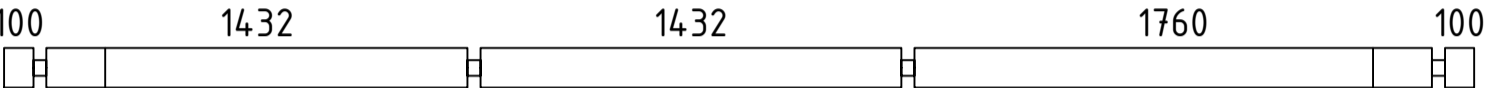
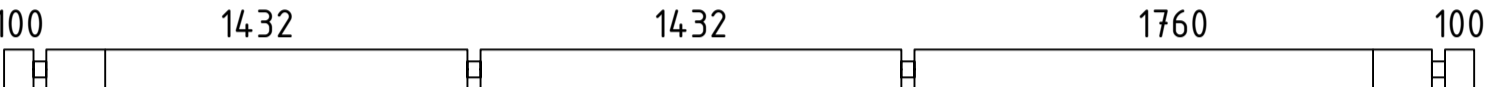
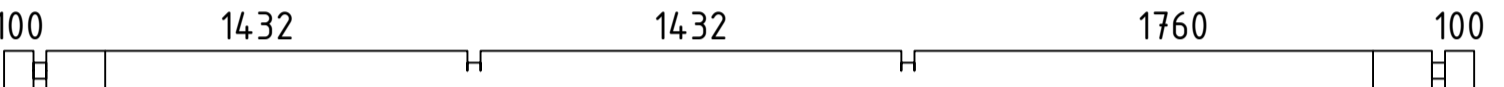
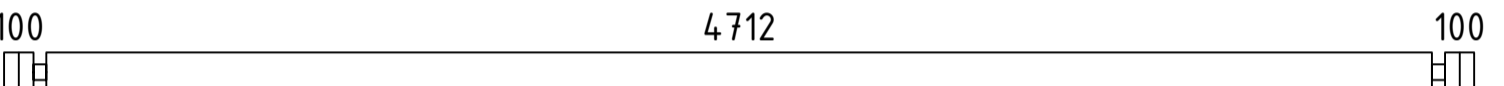
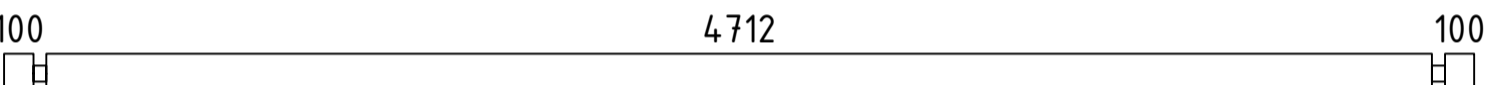
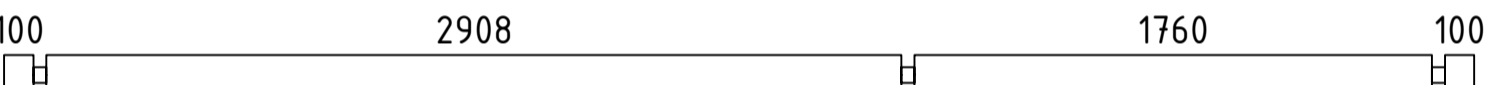
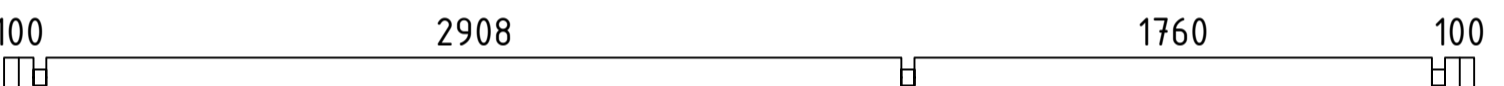

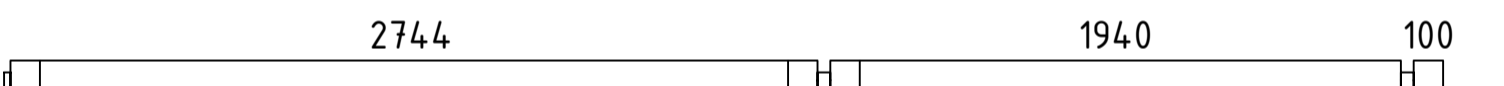
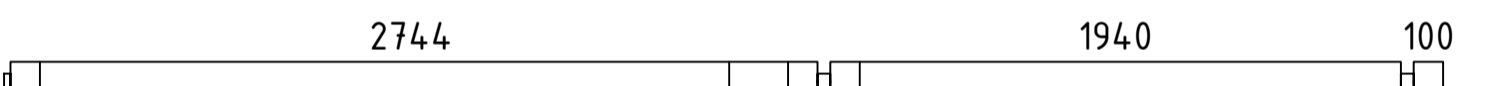
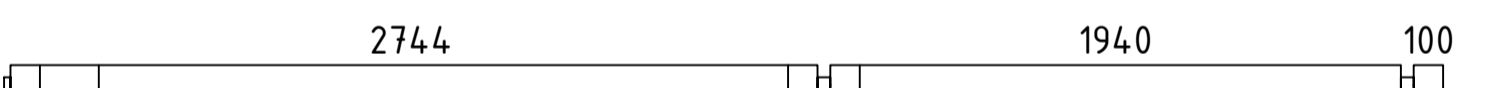
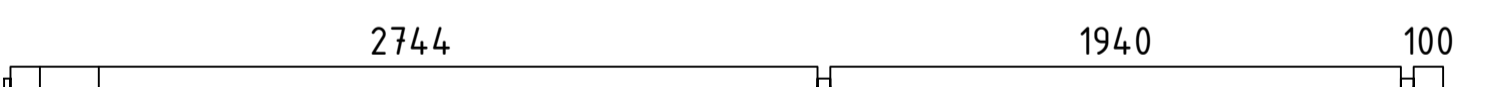
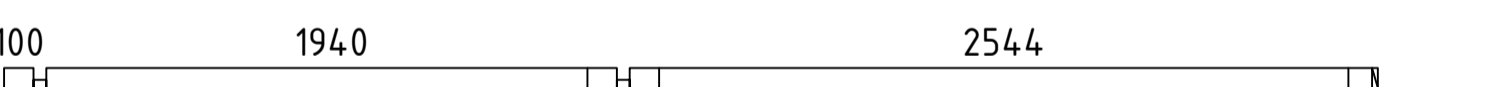
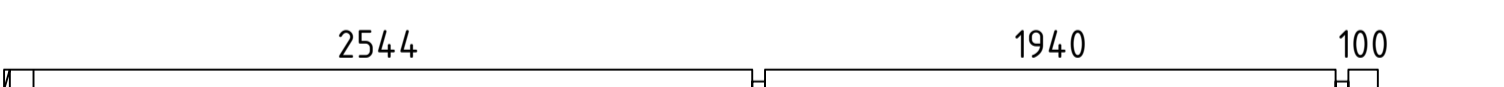

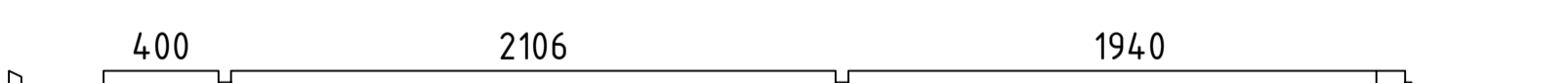



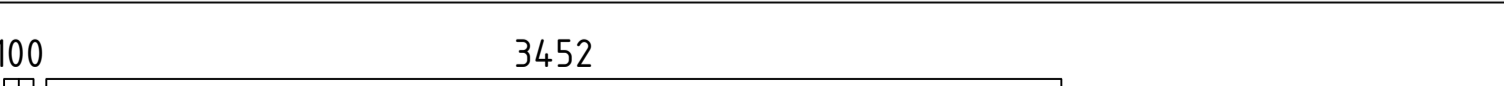
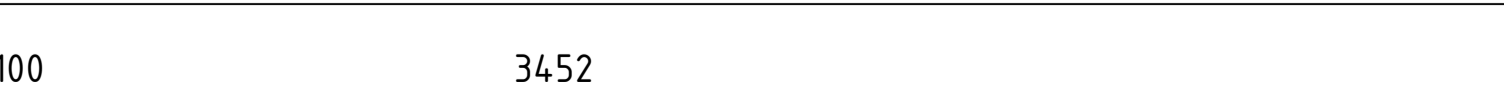

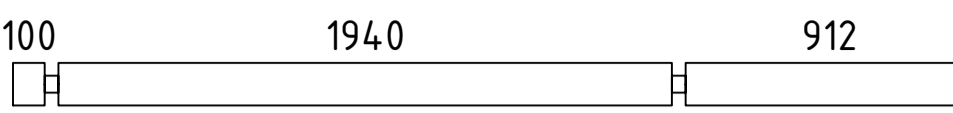
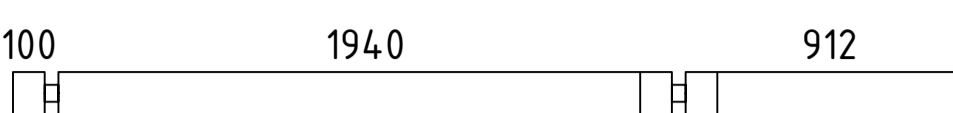
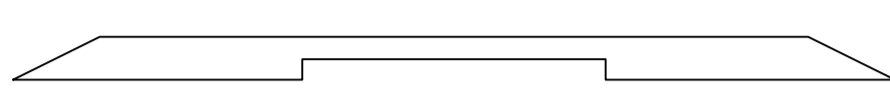
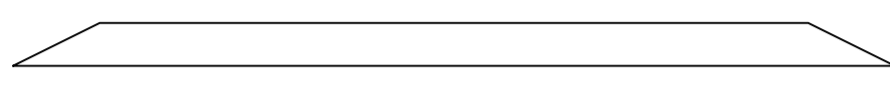
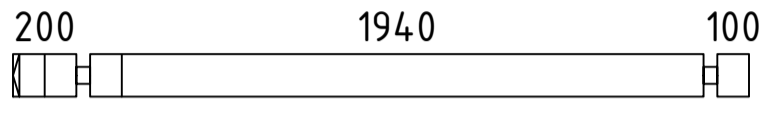
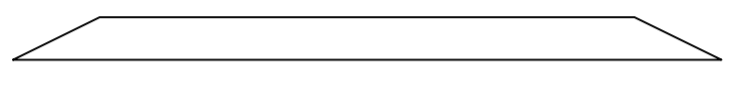
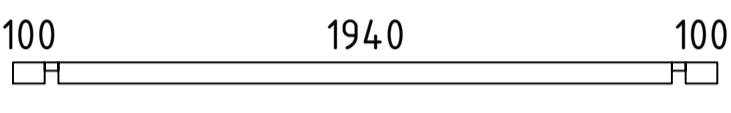
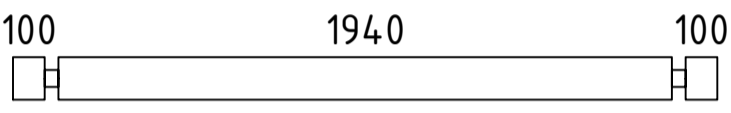
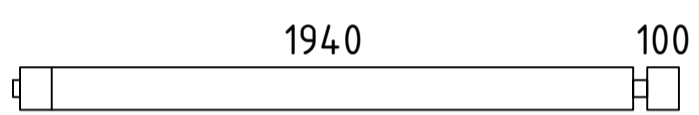
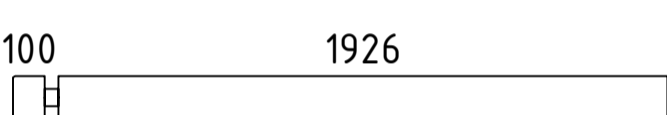
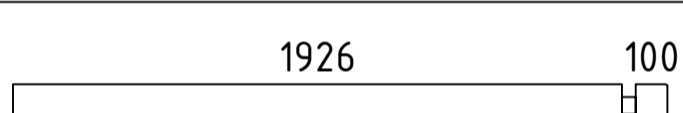
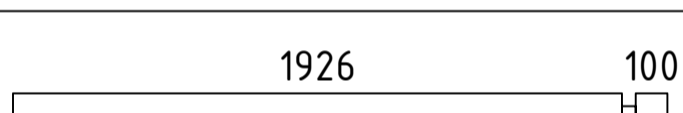
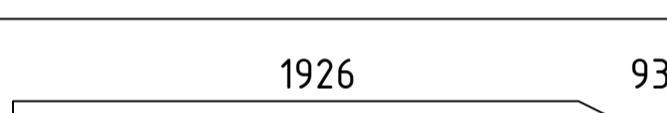
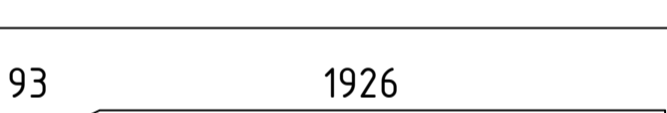
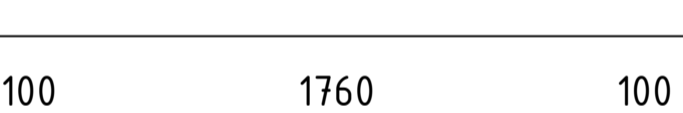
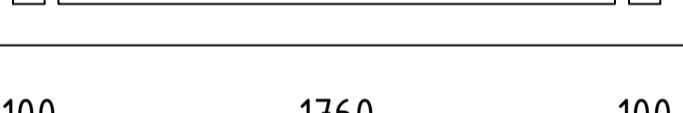
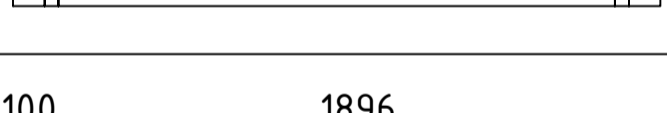
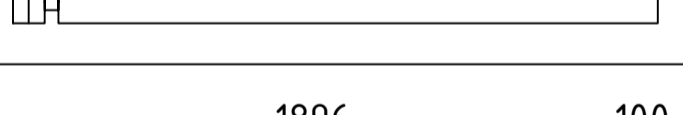
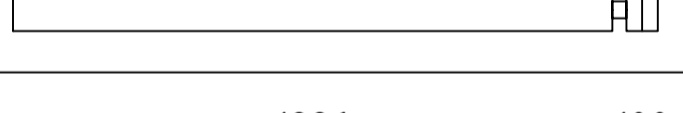
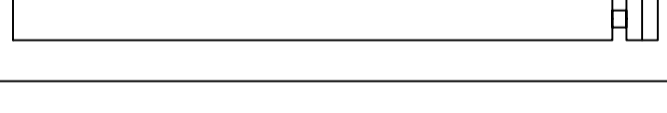
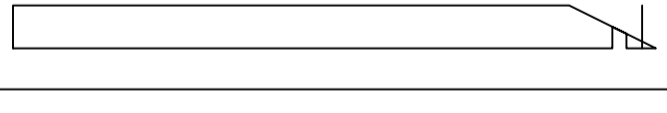
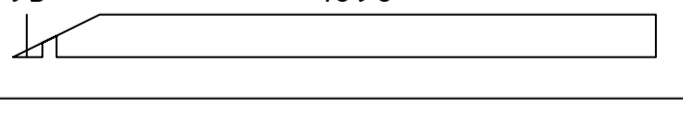
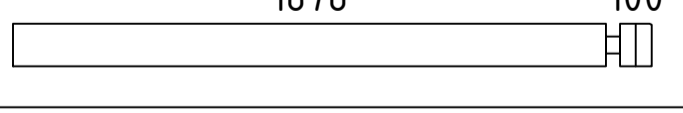
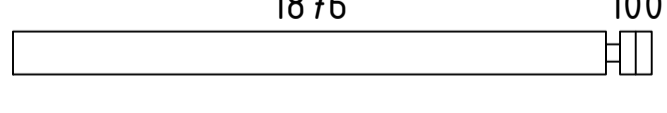
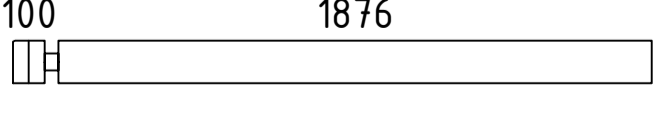

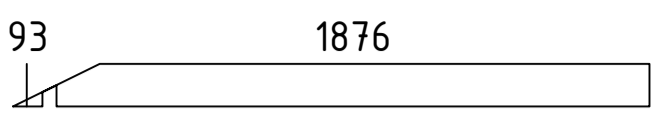
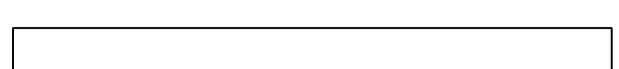
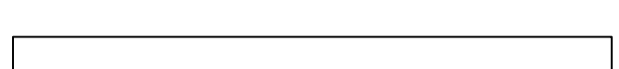
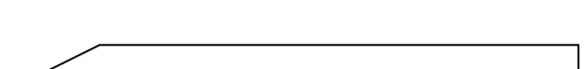
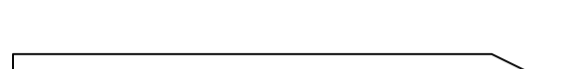
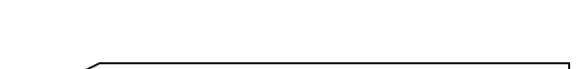
Name	Lord 5x7 MAX + BALKONY 500x700+VD_ 44		
Zerlegung/Drawing	Schlafboden balken - Sleeping floor beams/S44_LORDMAXBALCONY		
Profil/Profile	4.4x13.5	Maßstab/Scale	1:30
Druck auf/Print on	A3	Datum/Date	31.03.2026



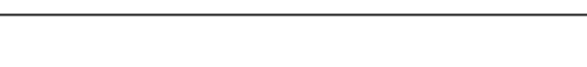
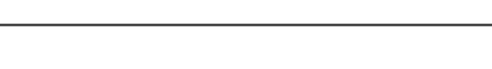
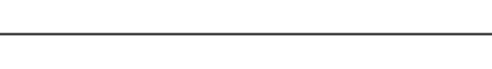

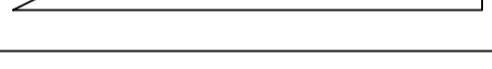
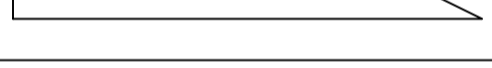

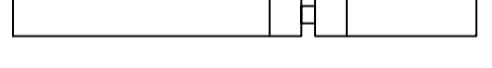
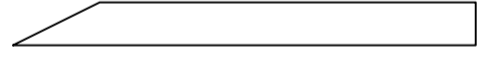
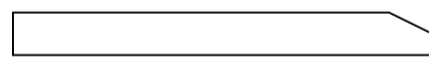
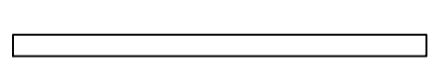
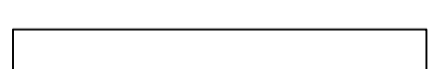
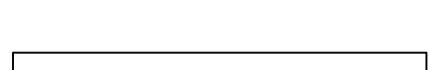
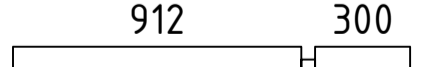

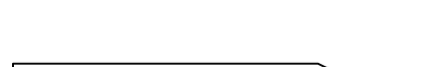

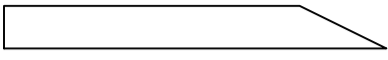
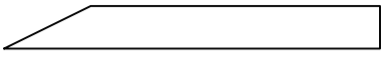
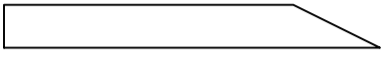
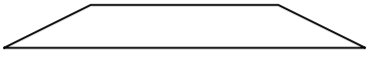
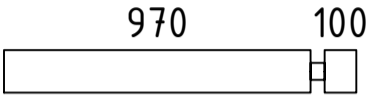
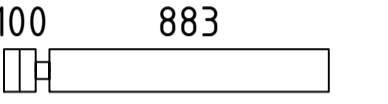
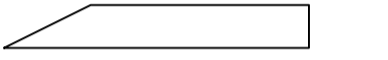
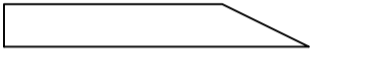
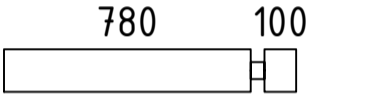
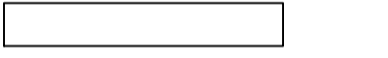
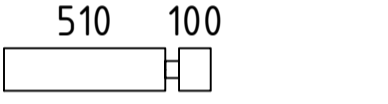
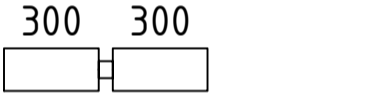

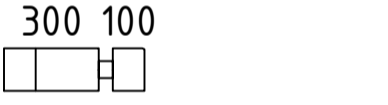

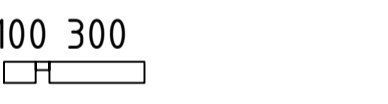

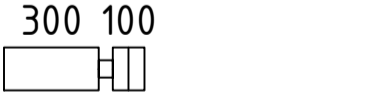







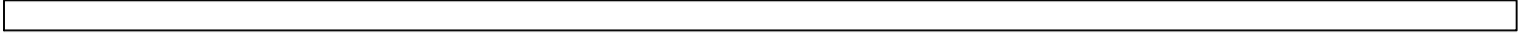











Name	Lord 5x7 MAX + BALKONY 500x700+VD_ 44		
Zeichnung/Drawing	Pfetten - Purlins	V\$44_LORDMAXBALCONY	
Profil/Profile	4.4x13.5	Maßstab/Scale	1:30
Druck auf/Print on	A3	Datum/Date	31.03.2026



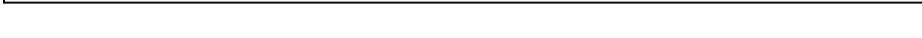
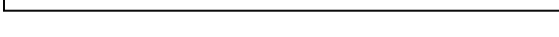





Pos	Teieliste/Specification Lord 5x7 MAX + BALKONY 500x700+VD_ 44	Pcs.	Profile (mm)	Length (mm)
	<u>Achtung!</u> Die Giebelbohlen können teilweise schon vormontiert sein! Bitte beachten - diese erscheinen nicht ganz so wie in der Teieliste beschrieben.			
	<u>Notice!</u> The gable pieces can be partly pre-assembled! Please notice - those differ from the description given in the specification list.			
1extra		1	44x135	5094
001		6	44x135	5094
002		1	44x135	5094
003		1	44x135	5094
004		1	44x135	5000
005		4	44x135	5000
006		1	44x135	5000
007		8	44x135	5000
008		3	44x135	5000
009		3	44x135	5000
010		18	44x135	5000
011		1	44x68	5000
012		14	44x135	4894
013		2	44x135	4894
014		4	44x135	4894
015		6	44x135	4894
016		2	44x135	4672
017		4	44x135	4672
018		1	44x135	4556
019		1	44x135	4556
020		4	44x135	4478
021		12	44x135	4256
022		2	44x135	4256
023		6	44x135	3596
024		1	44x68	3596
Kood	Lord 5x7 MAX + BALKONY 500x700+VD_ 44	Materjal		Leht 1/16

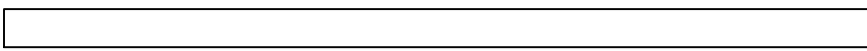
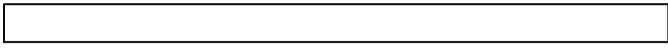
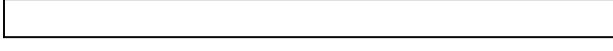
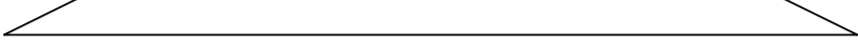

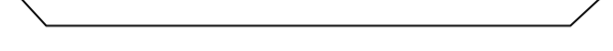
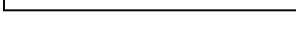
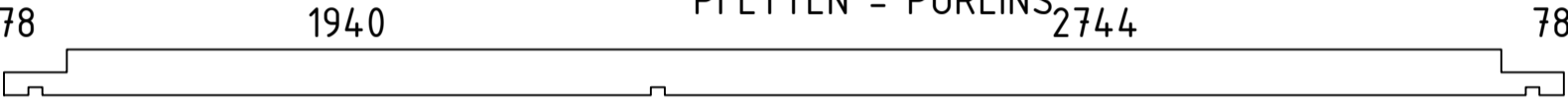
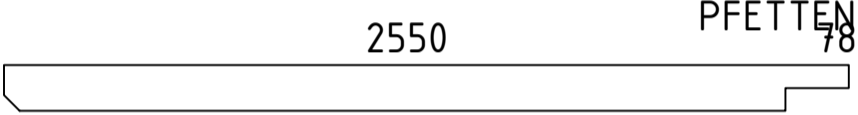
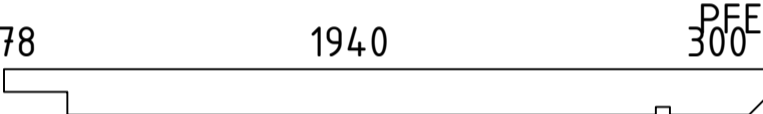
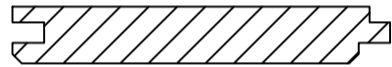
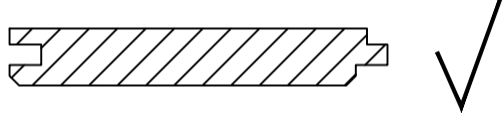
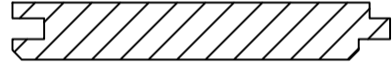
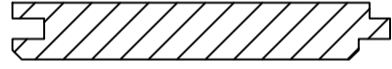
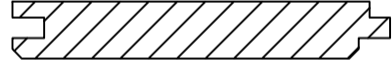

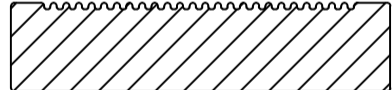

Pos	Teileliste/Specification Lord 5x7 MAX + BALKONY 500x700+VD_ 44	Pcs.	Profile (mm)	Length (mm)
025		19	44x135	3040
026		3	44x135	3040
027		1	44x135	2790
028		1	44x135	2790
029		2	44x135	2328
030		4	44x135	2241
031		1	44x68	2228
032		3	44x135	2228
033		18	44x135	2106
034		2	44x135	2070
035		2	44x135	2070
036		36	44x135	2070
037		2	44x135	2063
038		2	44x135	2063
039		15	44x135	2048
040		1	44x68	2048
041		1	44x135	2040
042		1	44x135	2040
043		8	44x135	2040
044		1	44x135	2033
045		1	44x135	2033
046		1	44x135	2020
047		18	44x135	2020
048		1	44x135	2020
049		1	44x135	2013
Kood	Lord 5x7 MAX + BALKONY 500x700+VD_ 44	Materjal		Leht 2/16

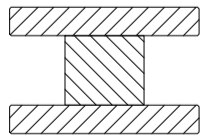
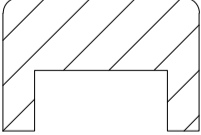
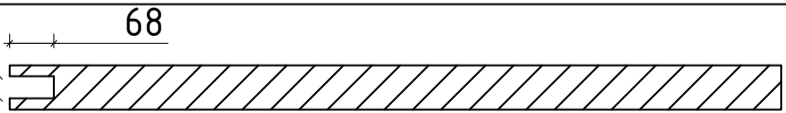
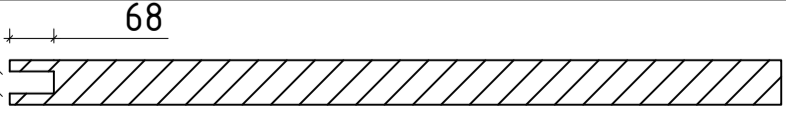
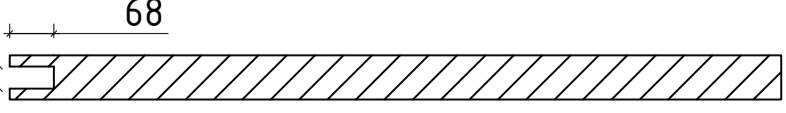

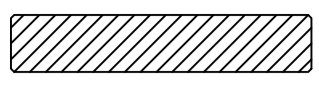
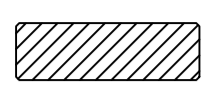
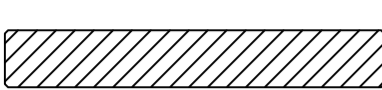

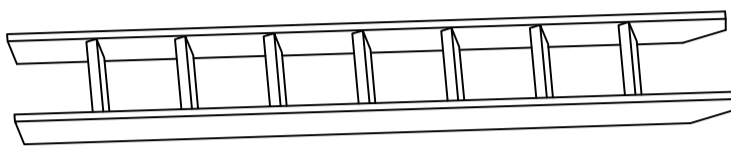
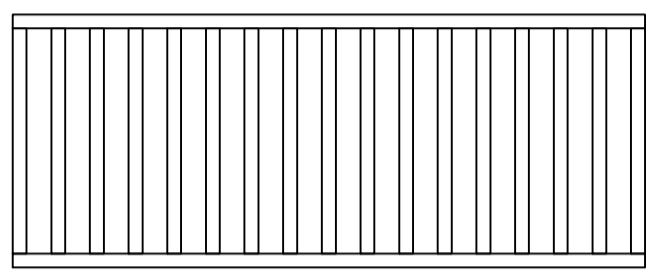
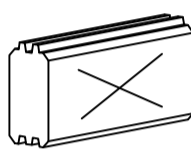
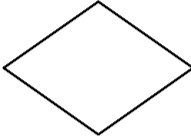
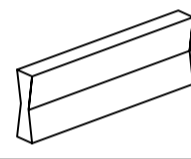
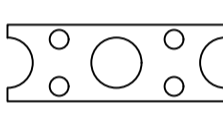
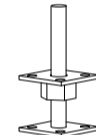
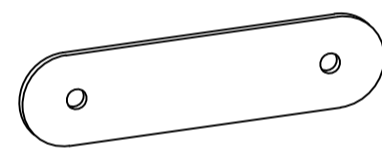
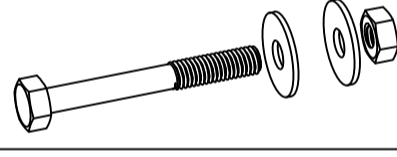
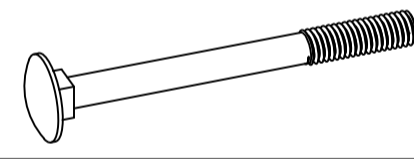
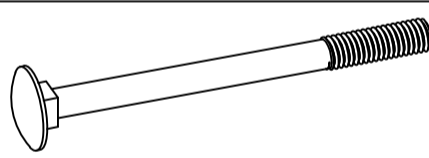
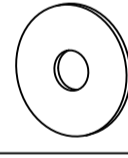
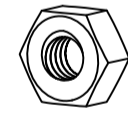

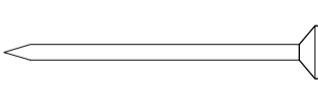

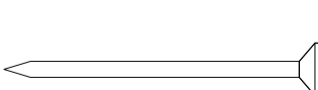
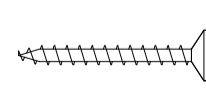
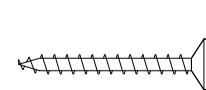
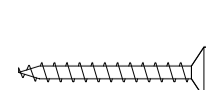

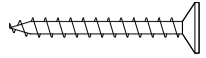
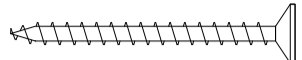
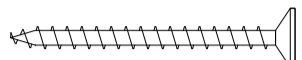
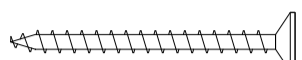

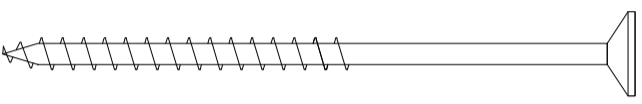
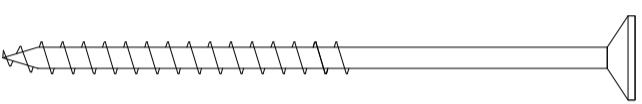
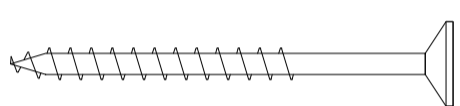
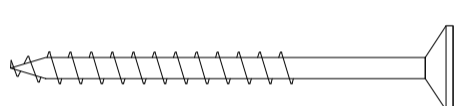
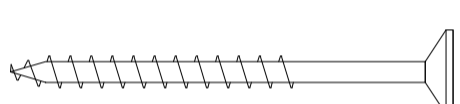
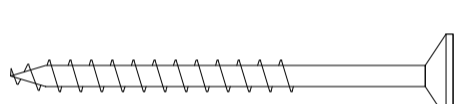
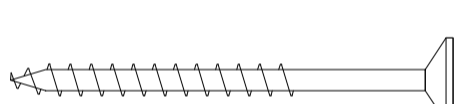
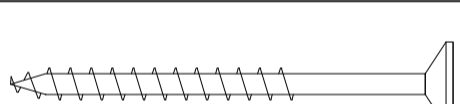
Pos	Teileliste/Specification Lord 5x7 MAX + BALKONY 500x700+VD_ 44	Pcs.	Profile (mm)	Length (mm)
050		1	44x135	2013
051		6	44x135	1894
052		2	44x135	1894
053		2	44x135	1789
054		2	44x135	1789
055		1	44x135	1759
056		1	44x135	1759
057		1	44x135	1739
058		1	44x135	1739
059		4	44x135	1691
060		2	44x135	1514
061		2	44x135	1514
062		1	44x135	1484
063		1	44x135	1484
064		8	44x135	1466
065		1	44x135	1466
066		1	44x135	1464
067		1	44x135	1464
068		2	44x68	1308
069		6	44x135	1308
070		2	44x68	1308
071		5	44x135	1256
072		2	44x135	1239
073		2	44x135	1239
074		1	44x135	1209
Kood	Lord 5x7 MAX + BALKONY 500x700+VD_ 44	Materjal		Leht 3/16

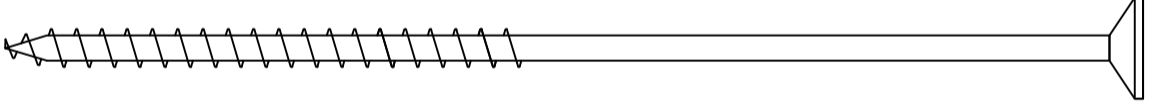
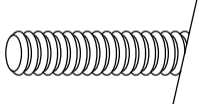
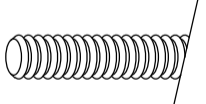
Pos	Teileliste/Specification Lord 5x7 MAX + BALKONY 500x700+VD_ 44	Pcs.	Profile (mm)	Length (mm)
075		1	44x135	1209
076		1	44x135	1189
077		1	44x135	1189
078		4	44x135	1142
079		5	44x135	1114
080		9	44x135	1027
081		2	44x135	965
082		2	44x135	965
083		15	44x135	924
084		9	44x135	883
085		9	44x135	654
086		4	44x135	644
087		10	44x135	444
088		1	44x135	444
089		80	44x135	444
090		3	44x68	444
091		2	44x68	444
092		1	44x135	444
093		1	44x68	444
094		15	44x135	444
095		1	44x135	437
096		1	44x135	437
097		48	44x135	280
098		12	44x135	278
099		4	44x135	275
Kood	Lord 5x7 MAX + BALKONY 500x700+VD_ 44	Materjal		Leht 4/16

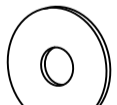
Pos	Teileliste/Specification Lord 5x7 MAX + BALKONY 500x700+VD_ 44		Pcs.	Profile (mm)	Length (mm)	
100			4	44x135	275	
FH3		FUNDAMENTHOLZ (imprägniert) - FOUNDATION BEAM (impregnated)	2	70x95	4784	
FH7		FUNDAMENTHOLZ (imprägniert) - FOUNDATION BEAM (impregnated)	3	70x95	4640	
FH4		FUNDAMENTHOLZ (imprägniert) - FOUNDATION BEAM (impregnated)	2	70x95	1996	
FH8		FUNDAMENTHOLZ (imprägniert) - FOUNDATION BEAM (impregnated)	12	45x95	4640	
FH9		FUNDAMENTHOLZ (imprägniert) - FOUNDATION BEAM (impregnated)	2	45x70	4690	
FH2		FUNDAMENTHOLZ (imprägniert) - FOUNDATION BEAM (impregnated)	2	45x70	2130	
FH6		FUNDAMENTHOLZ (imprägniert) - FOUNDATION BEAM (impregnated)	2	45x70	2040	
FH12		FUNDAMENTHOLZ (imprägniert) - FOUNDATION BEAM (impregnated)	4	45x70	1726	
FH10		FUNDAMENTHOLZ (imprägniert) - FOUNDATION BEAM (impregnated)	3	45x70	1443	
FH11		FUNDAMENTHOLZ (imprägniert) - FOUNDATION BEAM (impregnated)	3	45x70	1431	
FH13		FUNDAMENTHOLZ (imprägniert) - FOUNDATION BEAM (impregnated)	1	45x70	1398	
FH14		FUNDAMENTHOLZ (imprägniert) - FOUNDATION BEAM (impregnated)	1	45x70	1386	
FH5		FUNDAMENTHOLZ (imprägniert) - FOUNDATION BEAM (impregnated)	2	45x70	289	
FH15		FUNDAMENTHOLZ (imprägniert) - FOUNDATION BEAM (impregnated)	4	45x70	114	
FH1		FUNDAMENTHOLZ (imprägniert) - FOUNDATION BEAM (impregnated)	2	45x70	69	
DT4		DECKENTRÄGER - COVER CARRIER	✓	3	44x65	4707
DT2		DECKENTRÄGER - COVER CARRIER	✓	4	44x65	2903
DT3		DECKENTRÄGER - COVER CARRIER	✓	3	44x65	1755
DT5		DECKENTRÄGER - COVER CARRIER	✓	2	44x65	1427
DT1		DECKENTRÄGER - COVER CARRIER	✓	3	44x65	298
HL4		HANDLAUF - HANDRAIL	✓	1	120x18	4112
HL1		HANDLAUF - HANDRAIL	✓	2	120x18	1968
HL3		HANDLAUF - HANDRAIL	✓	2	120x18	1356
HL2		HANDLAUF - HANDRAIL	✓	1	18x95	2000
Kood	Lord 5x7 MAX + BALKONY 500x700+VD_ 44		Materjal		Leht 5/16	

Pos	Teileliste/Specification Lord 5x7 MAX + BALKONY 500x700+VD_ 44		Pcs.	Profile (mm)	Length (mm)
TB3	TRÄGEBALKE - SUPPORT BEAM 		8	44x120	2739
TB1	TRÄGEBALKE - SUPPORT BEAM 		12	44x120	2101
TB2	TRÄGEBALKE - SUPPORT BEAM 		25	44x120	1935
LT3	LATTEN - STUDS 		2	44x145	2699
LT2	LATTEN - STUDS 		1+1	44x145	2689
LT1	LATTEN - STUDS 		1+1	44x145	1949
GL1	GELÄNDER - HANDRAIL 		1	65x44	938
PF2	PFETTEN - PURLINS 		9	44x145	4972
PF1	PFETTEN - PURLINS 		9	44x145	2672
PF3	PFETTEN - PURLINS 		9	44x145	2406
	DACHBRETTER - ROOF BOARDS 		172+2	113x18	3064
	FUSSBODENBRETTER - FLOOR BOARDS 			113x18	192.0 lfm/rm
	FUSSBODENBRETTER - FLOOR BOARDS 		16	113x18	4723
	FUSSBODENBRETTER - FLOOR BOARDS 		16	113x18	1935
	SCHLAFBODENBRETTER - SLEEPING FLOOR BOARDS 		36+1	113x18	4707
	SCHLAFBODENBRETTER - SLEEPING FLOOR BOARDS 		25	113x18	2903
	TERRASSENBRETTER (imprägniert) - TERRACE BOARDS (impregnated) 		17+1	120x28	4707
	DECKENLEISTEN - CEILING STRIPS 			15x28	55.0 lfm/rm
	FUSSBODENLEISTEN - FLOOR STRIPS 			18x40	44.0 lfm/rm
	SCHLAFBODENLEISTEN - SLEEPING FLOOR STRIPS 			18x40	42.0 lfm/rm
A44-1	ADAPTER 44 		2	80x120	945
UP3-1	U-PROFIL - U-PROFILE 44 		6	44x65	945
TP1 20-1	STÜTZPFOSTE - SUPPORT POST 120x120 		1	120x120	2072
TP1 20-2	STÜTZPFOSTE - SUPPORT POST 120x120 		2	120x120	2228
TP1 20-3	STÜTZPFOSTE - SUPPORT POST 120x120 		2	120x120	2295
Kood	Lord 5x7 MAX + BALKONY 500x700+VD_ 44		Materjal		Leht 6/16

Pos	Teileliste/Specification Lord 5x7 MAX + BALKONY 500x700+VD_ 44			Pcs.	Profile (mm)	Length (mm)
G01-1	GIEBELBRETTER - GABLE BOARDS 18x95	26.2°		✓	4	18x95 3144
G06-1	GIEBELDECKLEISTEN - GABLE COVER STRIPS 18x58			✓	4	18x58 3144
T02-1	TRAUFENBRETTER - EAVES BOARDS 18x120				4	18x120 4825
T06-1	TRAUFENLEISTEN - EAVES STRIPS 18x40			✓		18x40 20.0 lfm/rm
TR02	LEITER - LADDER 2600mm				1	
	GELÄNDER - HAND RAIL				1	2000x800
SH	SCHLAGHÖLZER - MOUNTING PIECES				3	
GS	GIEBELSEGMENT - GABLE DIAMOND				4	
HK2	HOLZ-KLOTZEN für verbinden der Wandbohlen - Wooden wedge for connecting the wall parts (122mm)				6	
VS	Verbindungsstreifen für verbinden der Wandbohlen - Connecting strip for connecting the wall parts				34	
VP3	Verstellbare Pfostenstütze - Adjustable post support M20				5	
BFP	Befestigungsplatten für Sparren - Mounting plate for rafters				2	
SS412	Sechskantschrauben - Hex bolts M10x80 Mutter - Nut M10 U-Scheibe - Washer Ø30				2	
SS211	Schloßschrauben - Wood bolts M12x130				4	
SS1216	Schloßschrauben - Wood bolts M12x160				8	
US05	U-Scheibe - Washer M12 Ø40				12	
MUT21	Mutter - Nut M12				12	
NG2 550	NÄGEL - NAILS 2.5x50 Dachbretter - Roof boards				2064	
NG2 550	NÄGEL - NAILS 2.5x50 Fussbodenbretter - Floor boards				1208	
NG2 550	NÄGEL - NAILS 2.5x50 Schlafbodenbretter - Sleeping floor boards				1264	
NG2 550	NÄGEL - NAILS 2.5x50 Terrassenbretter - Terrace boards				442	
SR3 030	Schrauben - Screws 3.0x30 Fussbodenleisten - Floor strips				86	
SR3 030	Schrauben - Screws 3.0x30 Giebeldeckleisten - Gable cover strips				24	
SR3 030	Schrauben - Screws 3.0x30 Schlafbodenleisten - Sleeping floor strips				86	
Kood	Lord 5x7 MAX + BALKONY 500x700+VD_ 44			Materjal	Leht 7/16	

Pos	Teileliste/Specification Lord 5x7 MAX + BALKONY 500x700+VD_ 44			Pcs.	Profile (mm)	Length (mm)
SR3 030	Schrauben - Screws 3.0x30	Traufenleisten - Eaves strips		30		
SR3 545	Schrauben - Screws 3.5x45	Giebelbretter - Gable boards		24		
SR3 545	Schrauben - Screws 3.5x45	Giebelsegment - Gable diamond		4		
SR3 545	Schrauben - Screws 3.5x45	Handlauf - Handrail		31		
SR3 545	Schrauben - Screws 3.5x45	Traufenbretter - Eaves boards		30		
SR354 5-001	Schrauben - Screws 3.5x45	Verbindungsstreifen - Connecting strip		136		
SR57	Schrauben - Screws 5.0x100	Geländer - Hand rail		16		
SR5 0100	Schrauben - Screws 5.0x100	Fundamenthölzer - Foundation beams		180		
SR55	Schrauben - Screws 5.0x70	Geländer - Hand rail		16		
SR5 070	Schrauben - Screws 5.0x70	Deckenträger - Cover Carrier		120		
SR5 070	Schrauben - Screws 5.0x70	Geländer - Handlauf		16		
SR5 070	Schrauben - Screws 5.0x70	Stützpfole - Support post		2		
SR5 070	Schrauben - Screws 5.0x70	Trägebalken - Support beam		176		
SR507 0-002	Schrauben - Screws 5.0x70	Verstellbare pfostenstütze - Post support		8		
SR62	Schrauben - Screws 6.0x140 (ASSY für Pfetten - for purlins)		54			
SR6 0180	Schrauben - Screws 6.0x180	Sparren - Rafters		10		
KL1	Gewindestange - Threaded Rod M8			8		2000
KL2	Gewindestange - Threaded Rod M8			2		1755
KV M UT M8	Mutter - Nut M8			12		
KV S EIB M8X25	U-Scheibe - Washer M8 Ø25			12		
KV MU TJ M8	Befestigungsmutter - Fixing nut M8			8		
ML1	Metallstange - Metal bar			6	D10	1040
ML2	Metallstange - Metal bar			2	D10	1030
ML3	Metallstange - Metal bar			8	D10	900
ML4	Metallstange - Metal bar			2	D10	770
Kood	Lord 5x7 MAX + BALKONY 500x700+VD_ 44			Materjal		Leht 8/16

1

NB! Bohren Sie ein Loch for / Predrill a hole

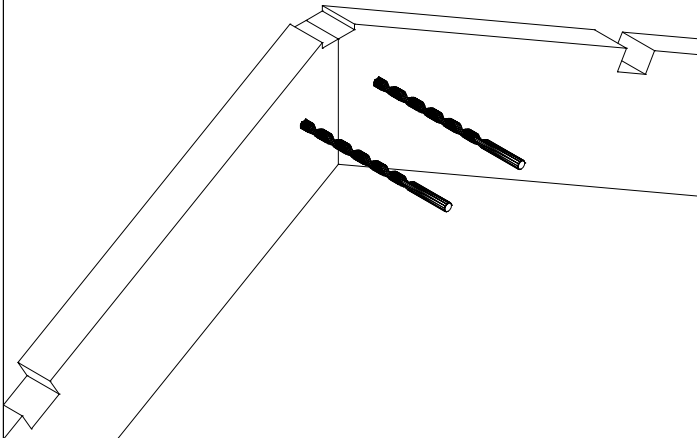

2

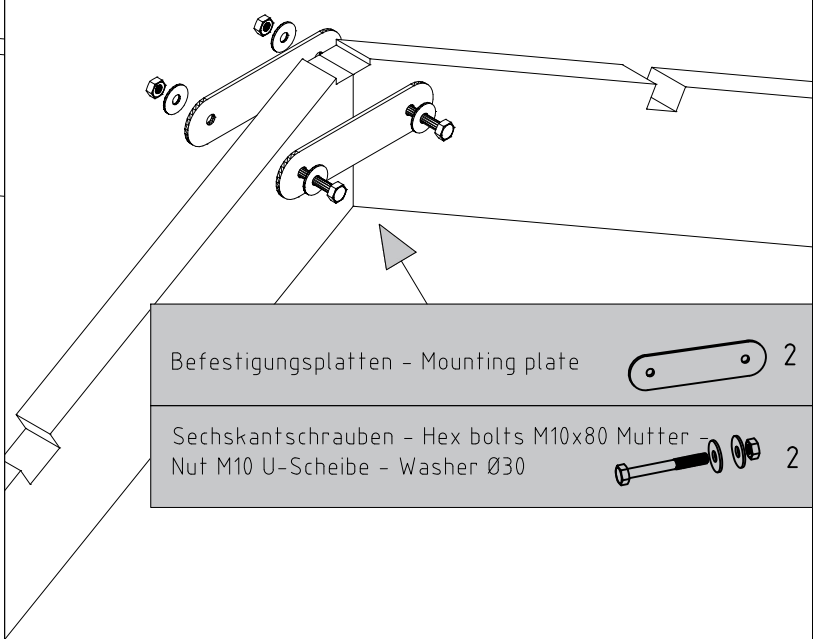

Befestigungsplatten - Mounting plate



2

Sechskantschrauben - Hex bolts M10x80 Mutter - Nut M10 U-Scheibe - Washer Ø30



2

3

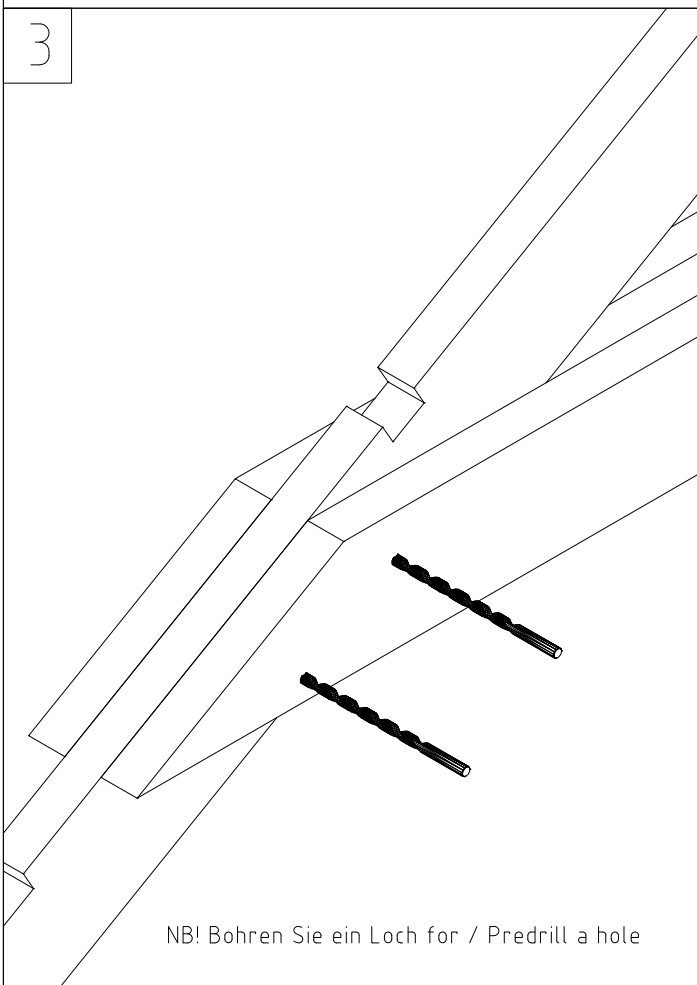

NB! Bohren Sie ein Loch for / Predrill a hole

4

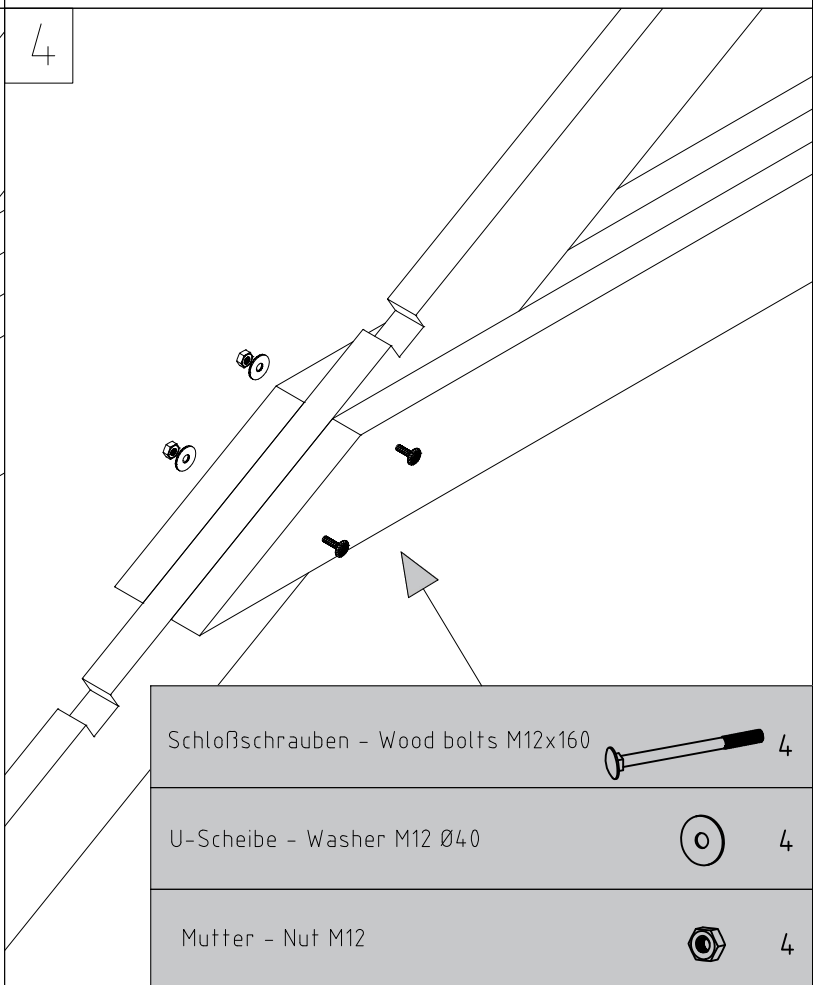

Schloßschrauben - Wood bolts M12x160



4

U-Scheibe - Washer M12 Ø40



4

Mutter - Nut M12



4

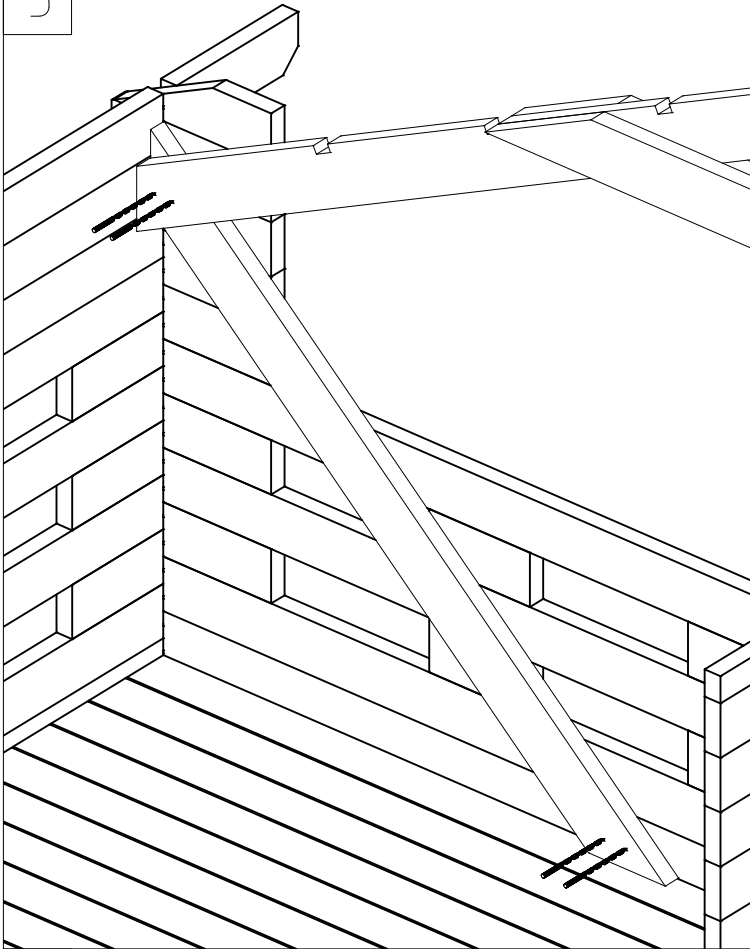

5

NB! Bohren Sie ein Loch for / Predrill a hole

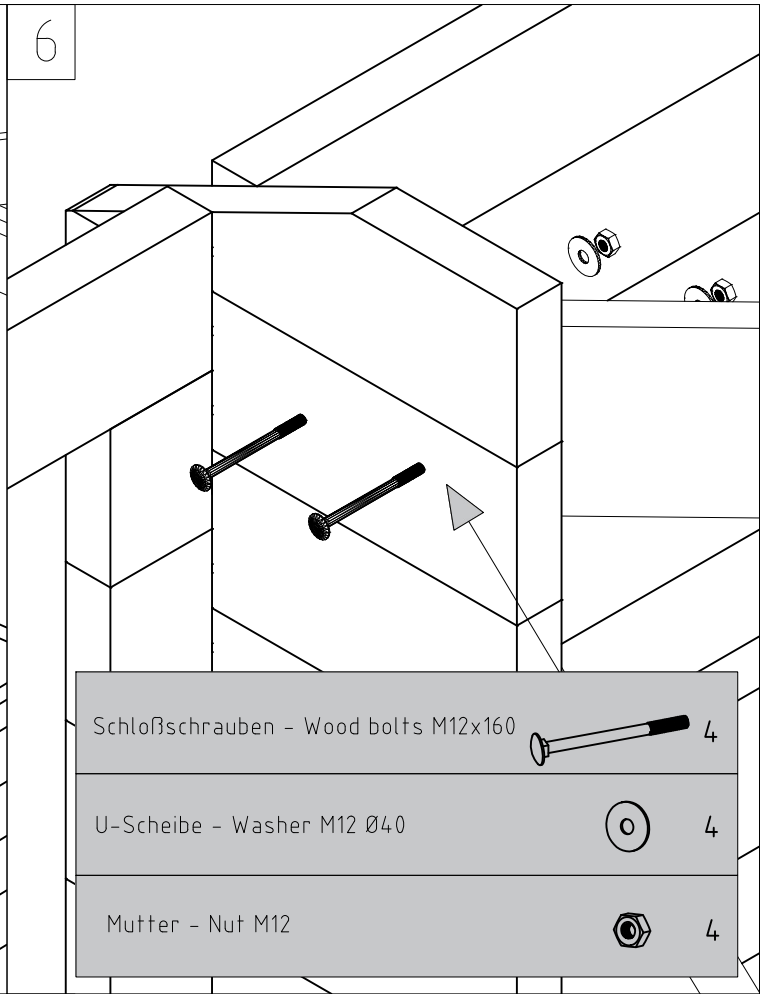

6



Schloßschrauben - Wood bolts M12x160		4
U-Scheibe - Washer M12 Ø40		4
Mutter - Nut M12		4

7

Schloßschrauben - Wood bolts M12x130

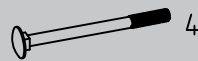

4

U-Scheibe - Washer M12 Ø40



4

Mutter - Nut M12



4

8

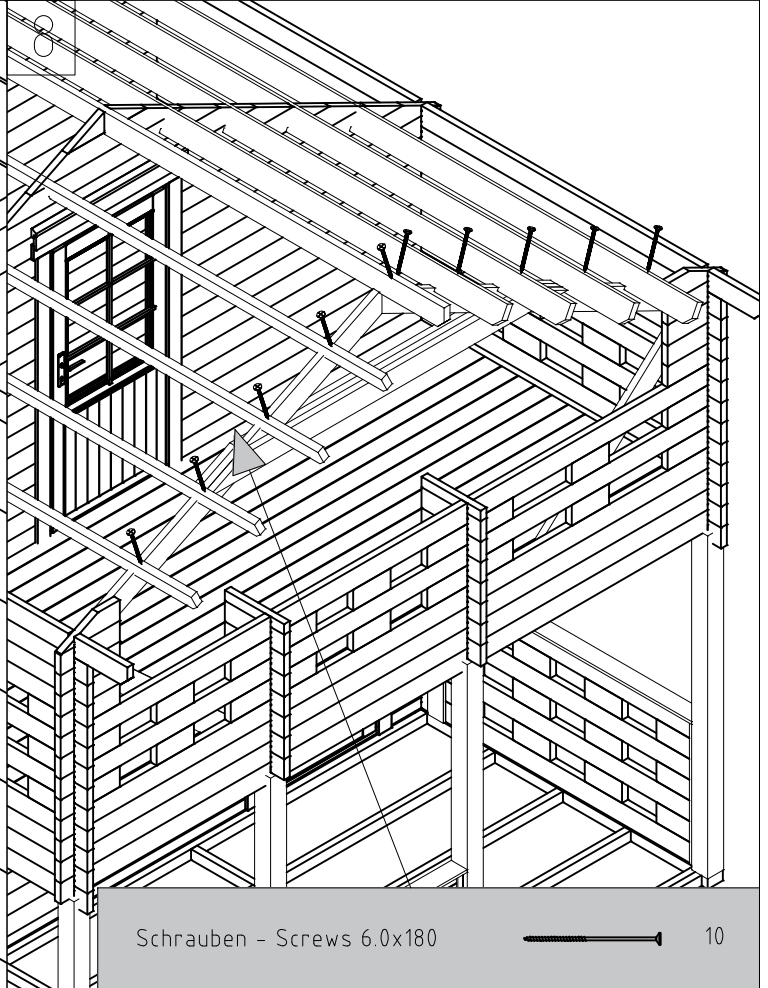

Schrauben - Screws 6.0x180



10

Vihmaliist / Rain strip / Wasserleiste

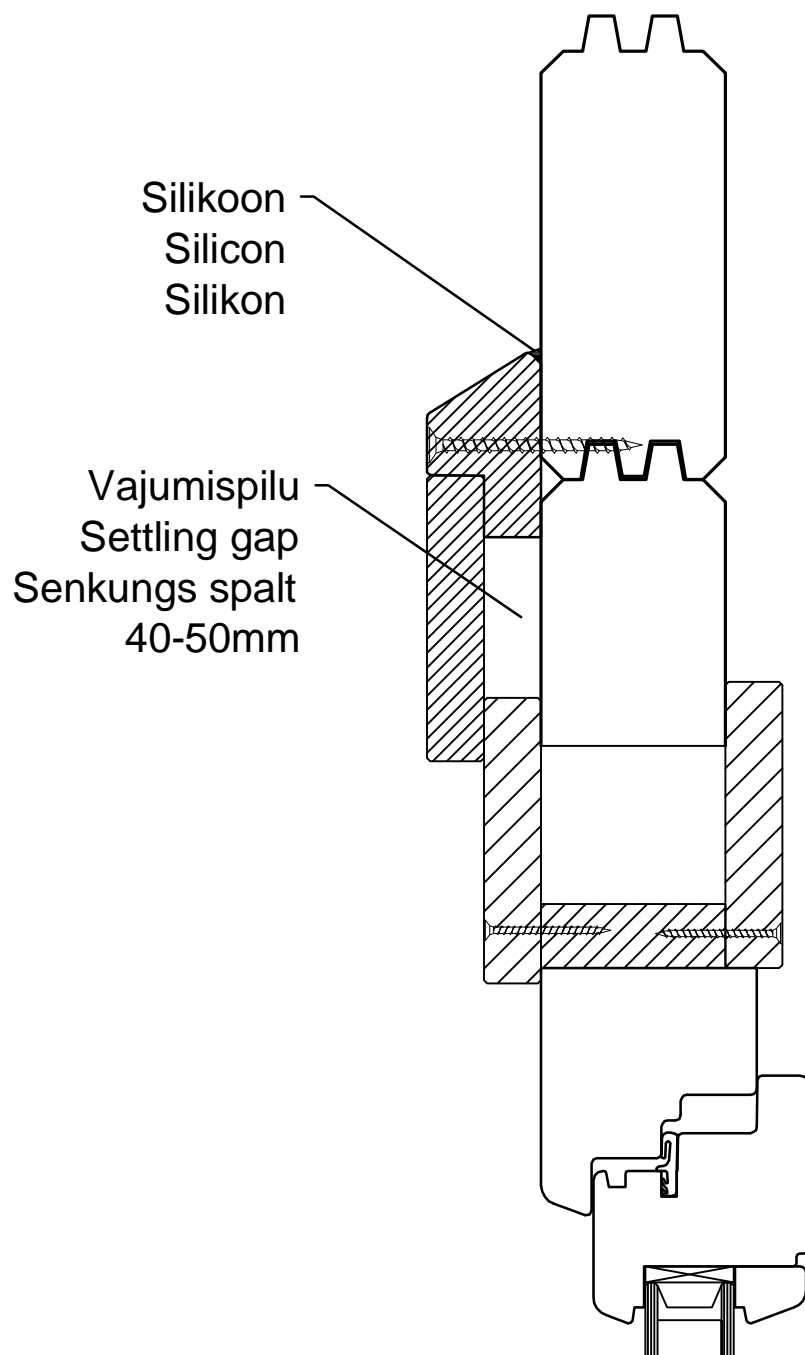

NB!

- Monteerida juhul kui ese on välja toodud maja spetsifikatsioonis!
- Install only if the item is listed in the house specification!
- Nur montieren wenn die Leiste in der Teileliste gezeigt ist!

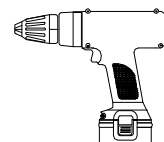

Aken	Q4-Q6	-	paigaldusjuhhis
Window	Q4-Q6	-	assembly instructions
Fenster	Q4-Q6	-	Montageanleitung

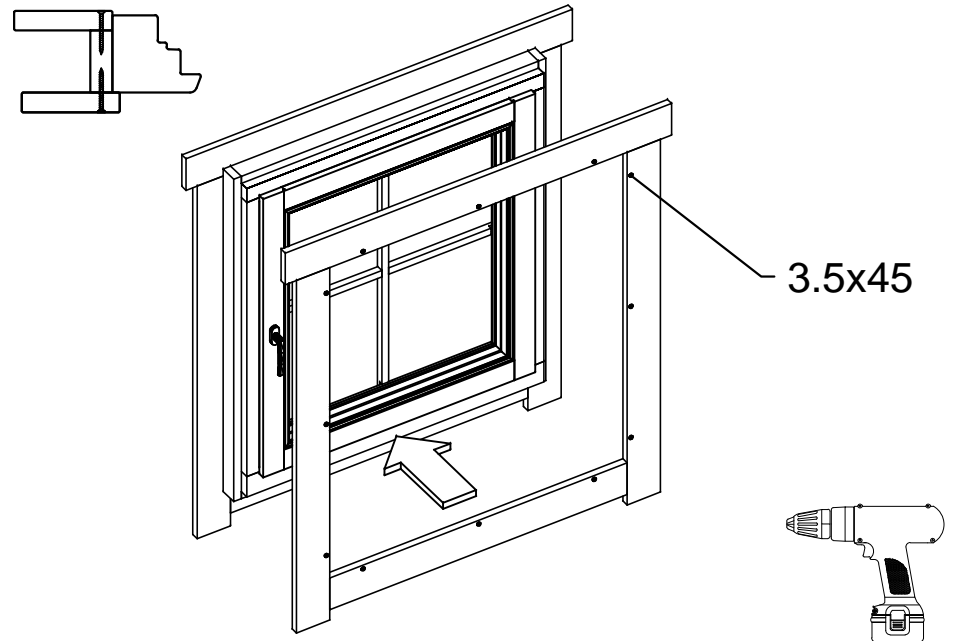
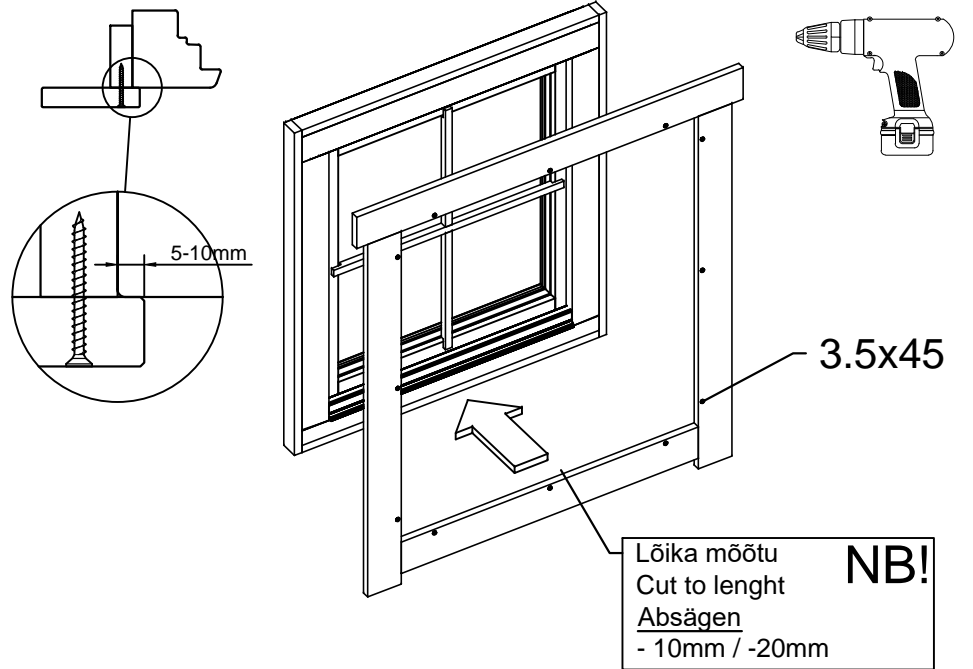
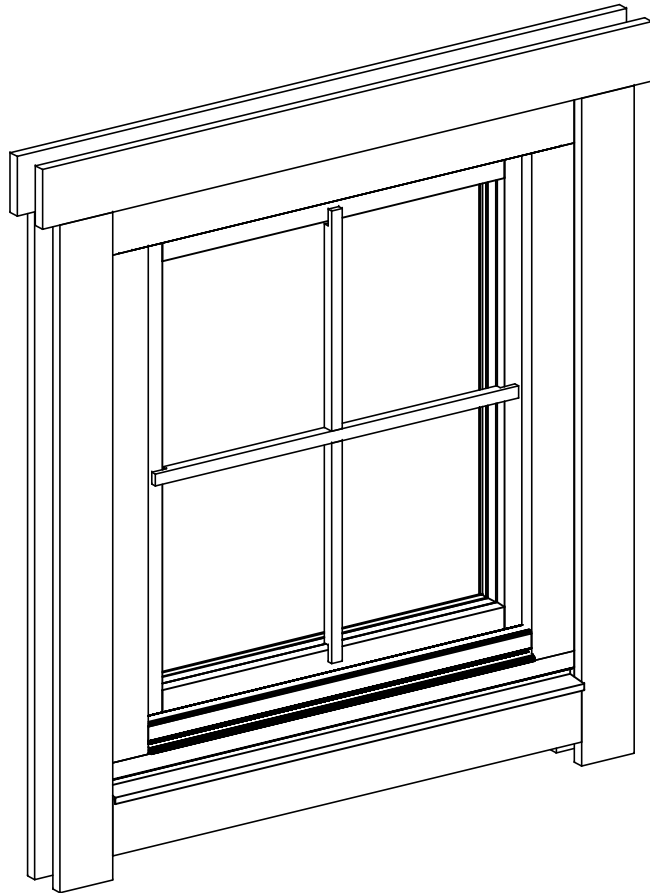

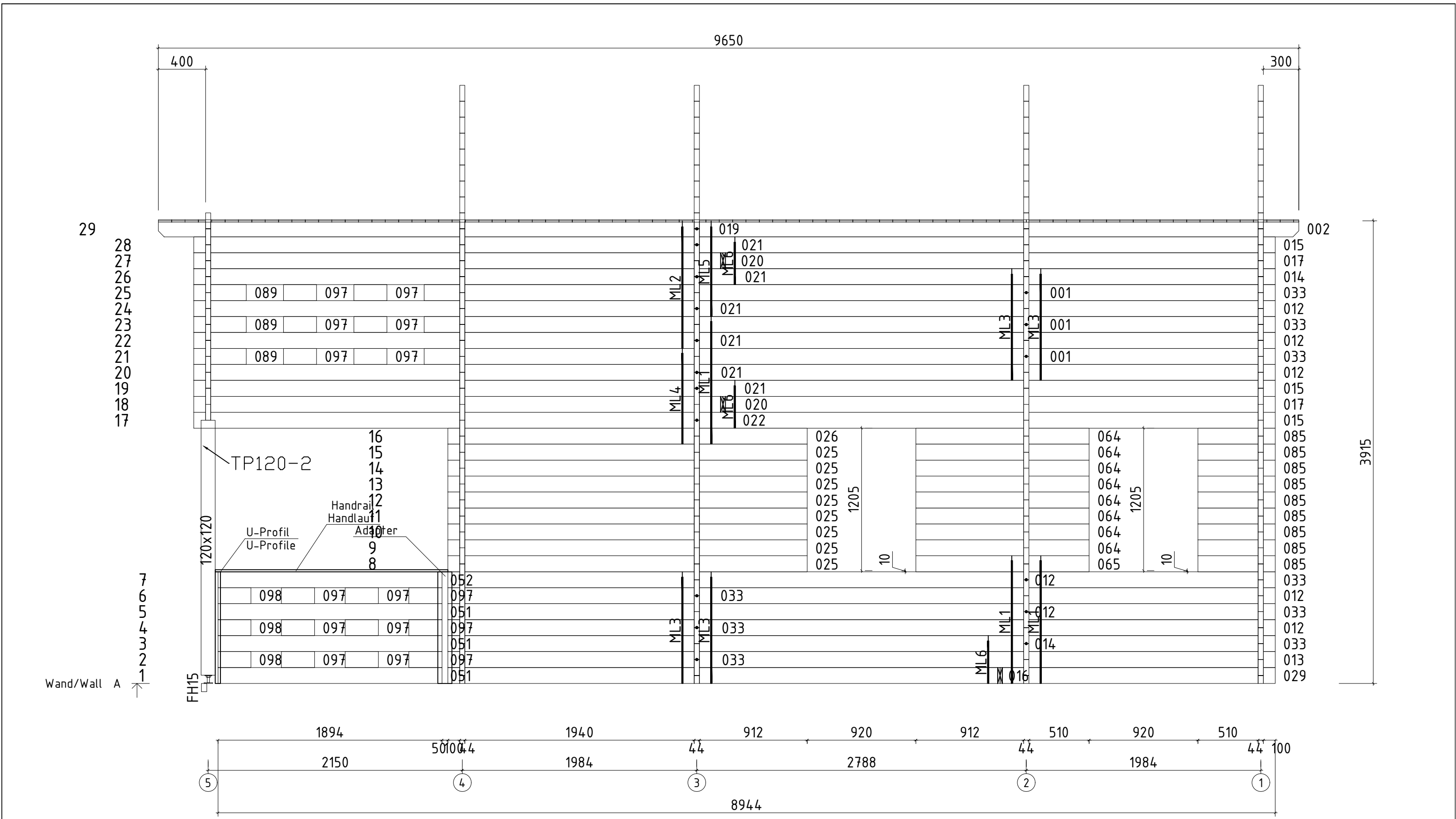

Wand/Wall A

Giebeldeckleisten
 Gable cover strips
 Dachbretter
 Roof boards 18x113
 Giebelbretter
 Gable boards
 Pfetten/Wandbohlen
 Purlins/Wall log

Name	Lord 5x7 MAX + BALKONY 500x700+VD_ 44		
Zeichnung/Drawing	WAND/WALL A	VS_44_LORDMAXBALCON	
Profil/Profile	4.4x13.5	Maßstab/Scale	1:30
		Druck auf/Print on	A3
		Datum/Date	31.03.2026

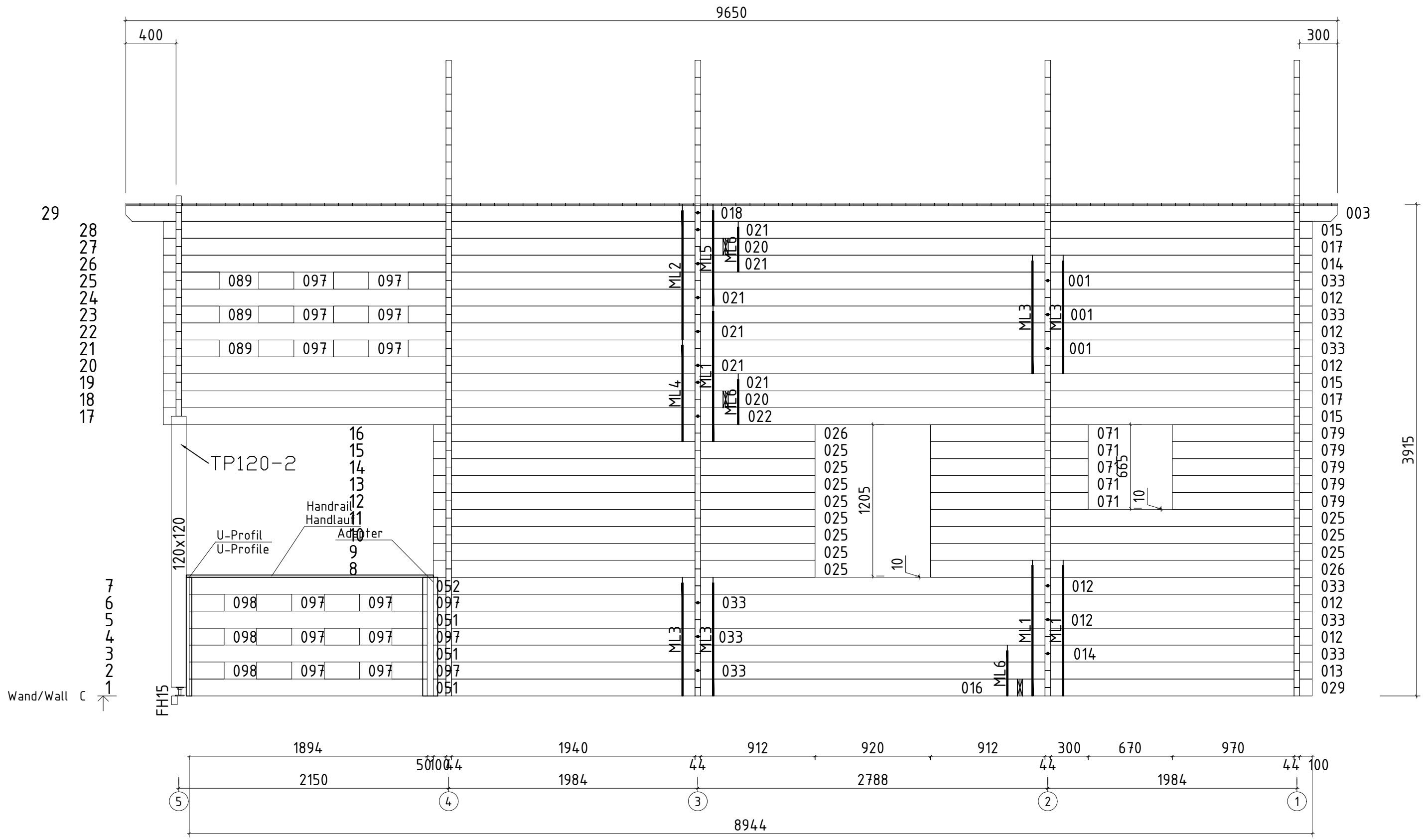

Name	Lord 5x7 MAX + BALKONY 500x700+VD_ 44		
Zeichnung/Drawing	WAND/WALL C	VS_44_LORDMAXBALCON	
Profil/Profile	4.4x13.5	Maßstab/Scale	1:30
		Druck auf/Print on	A3
		Datum/Date	31.03.2026

- Dachbretter
- Roof boards
- Traufenbretter
- Gable boards
- Traufenleisten
- Eaves strips

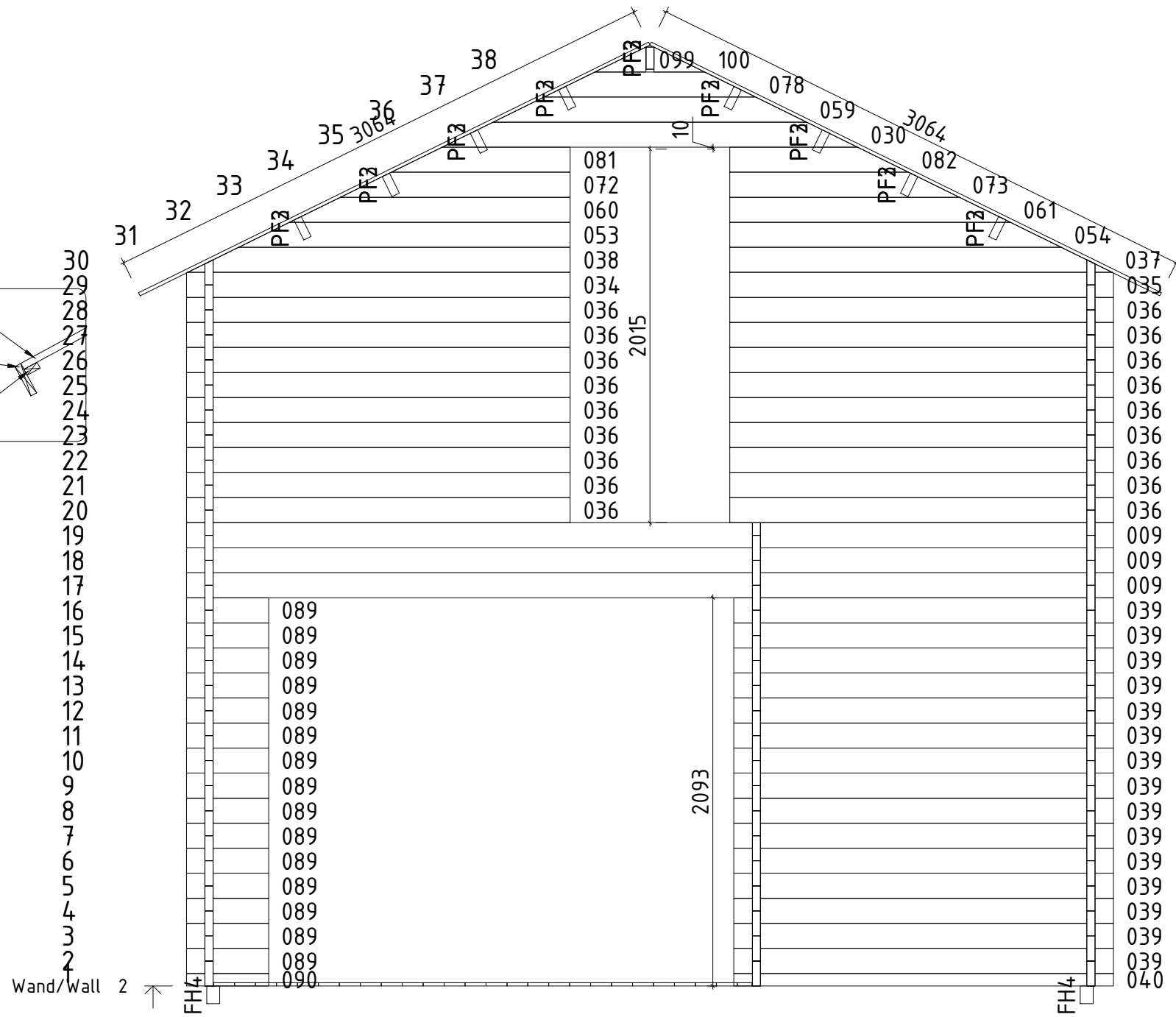

- Dachbretter
- Roof boards
- Traufenbretter
- Gable boards
- Traufenleisten
- Eaves strips

- Wandbohlen
- Wall logs
- Fussbodenleiste
- Floor strip
- Fussbodenbretter
- Floor boards 18x113
- Fundamenthölzer
- Foundation beams

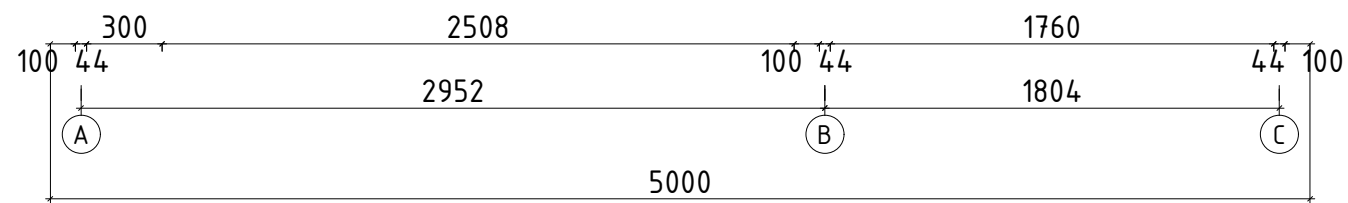

5063

Name	Lord 5x7 MAX + BALKONY 500x700+VD_ 44		
Zeichnung/Drawing	WAND/WALL 2	VS_44	LORDMAXBALCON
Profil/Profile	4.4x13.5	Maßstab/Scale	1:30
Druck auf/Print on	A3	Datum/Date	31.03.2026

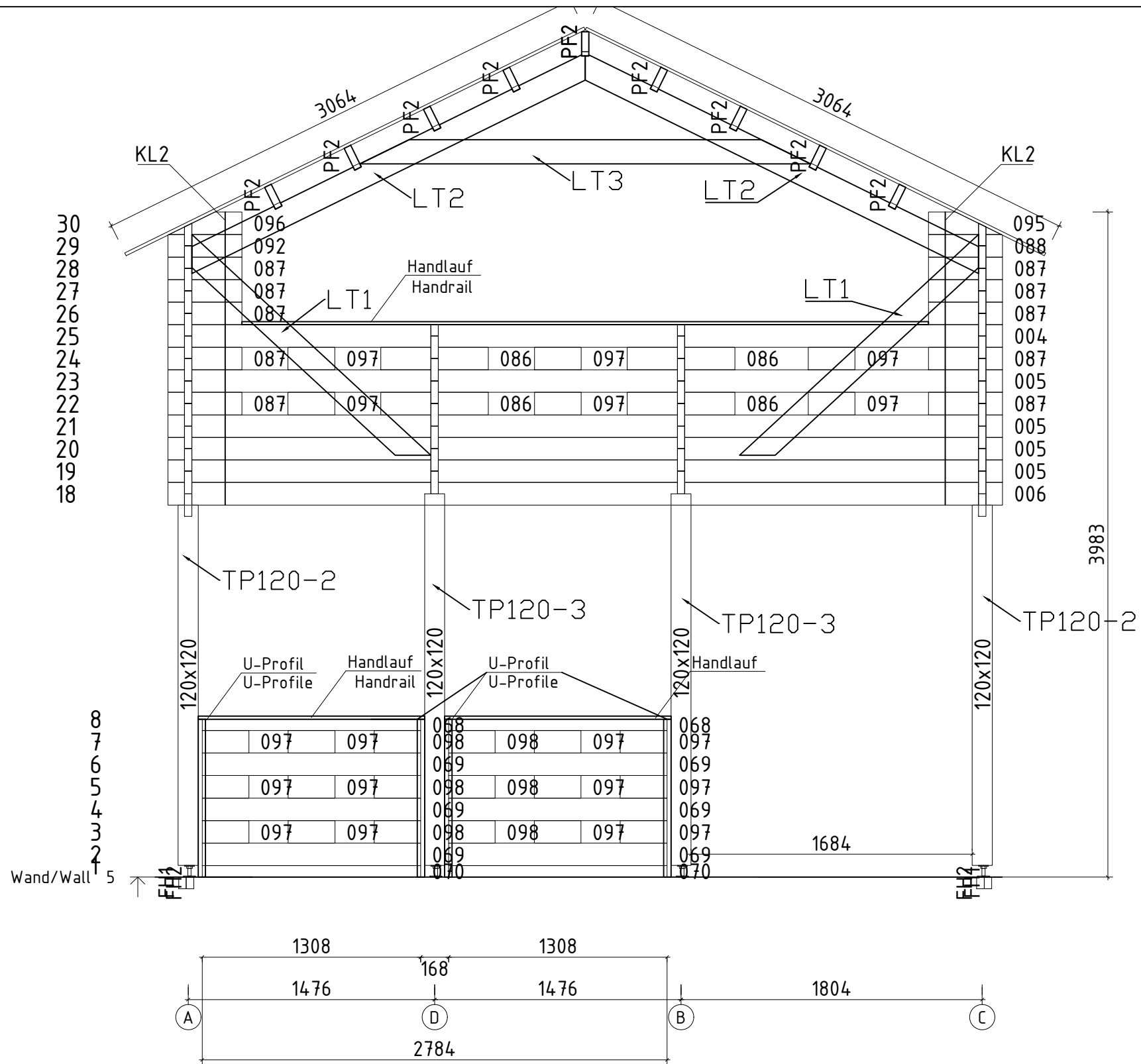

Name	Lord 5x7 MAX + BALKONY 500x700+VD_ 44		
Zeichnung/Drawing	WAND/WALL 5	VS44_LORDMAXBALCON	
Profil/Profile	4.4x13.5	Maßstab/Scale	1:30
		Druck auf/Print on	A3
		Datum/Date	31.03.2026