

Art. Nr. 4438102

1/9

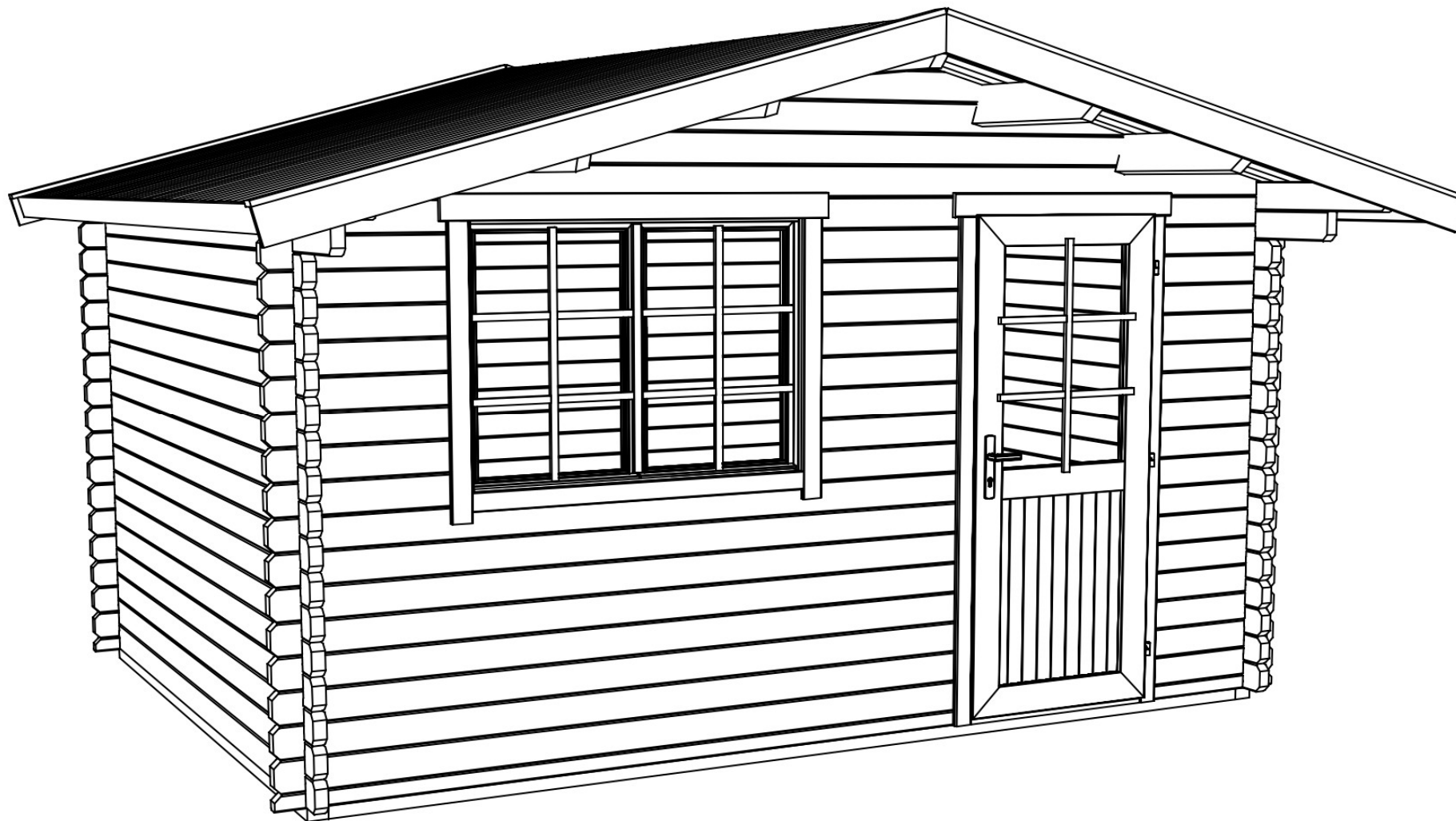

05.05.2025

Art.Nr. 4438102

Groundplan - Grundplan - Plan de masse - Planimetria - Plattegrond - Planimetría  
- Põhiplaan

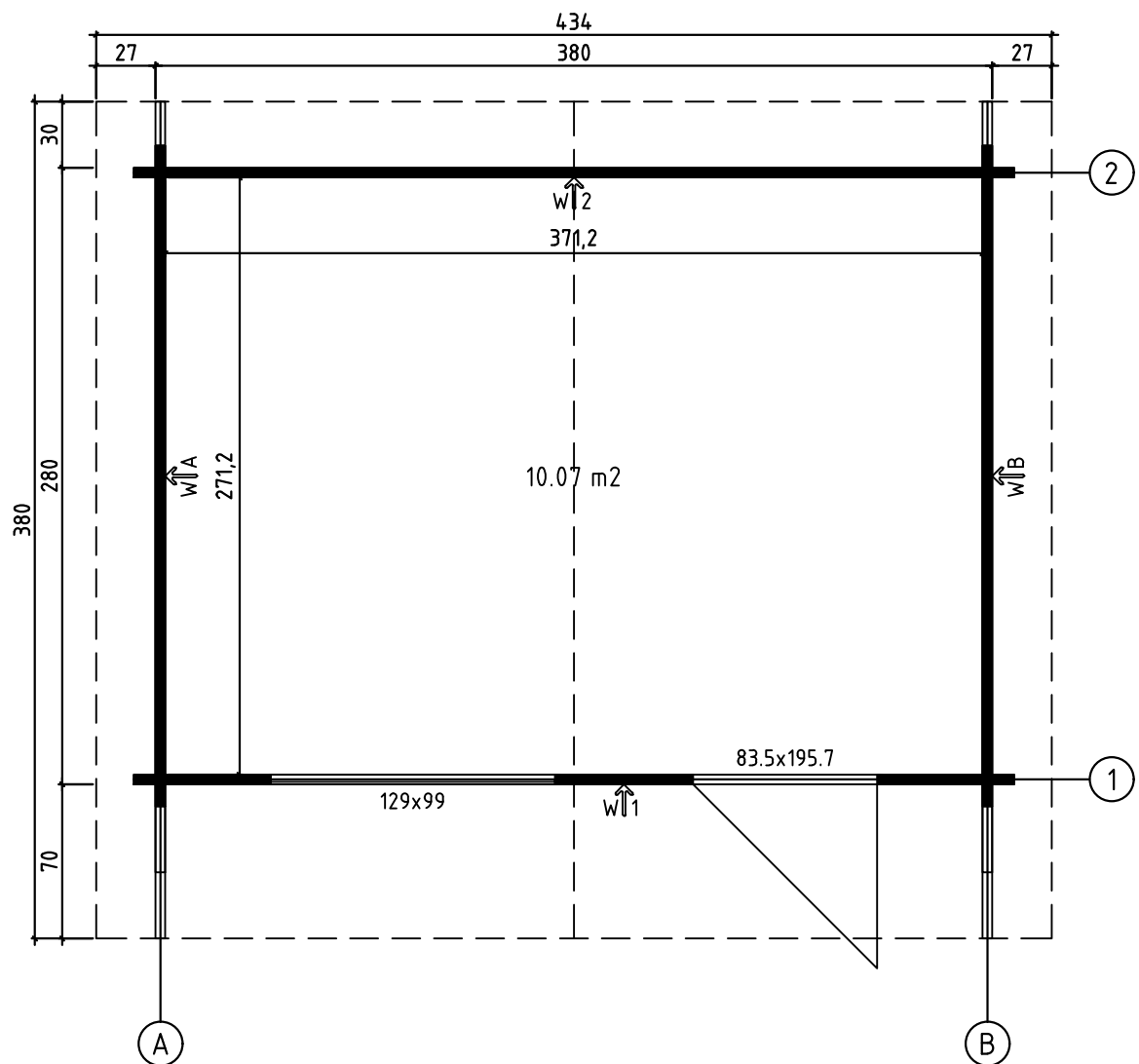

Art.Nr. 4438102

Foundation - Fundament - Fondation - Fondamenta - Fundering - Bastidor  
- Immutatud alusraam

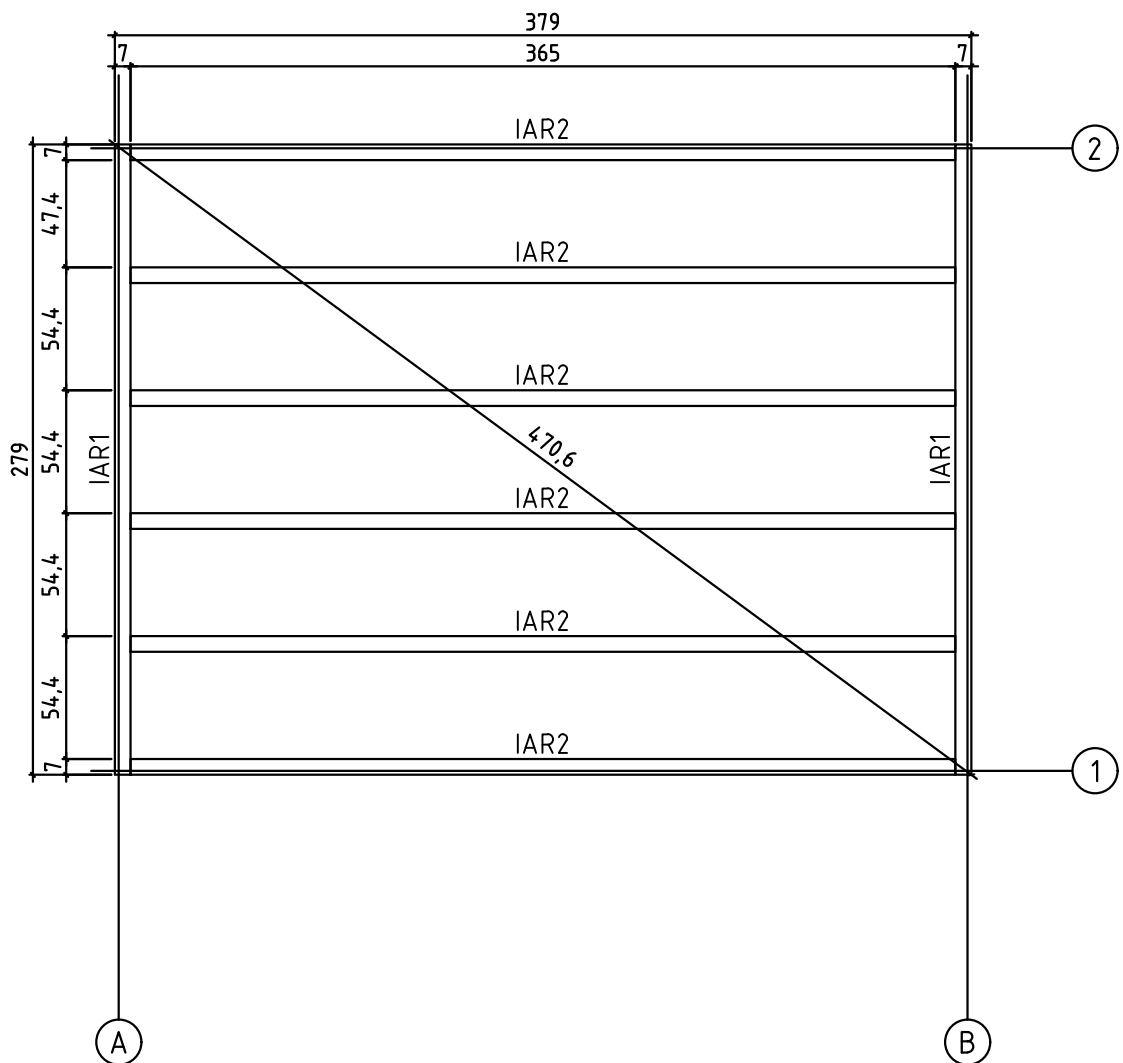

Art.Nr. 4438102

Floor boards - Fussbodenbretter - Lame de plancher - Pavimento - Vloerhout  
- Tablero de suelo - Põrandalaud

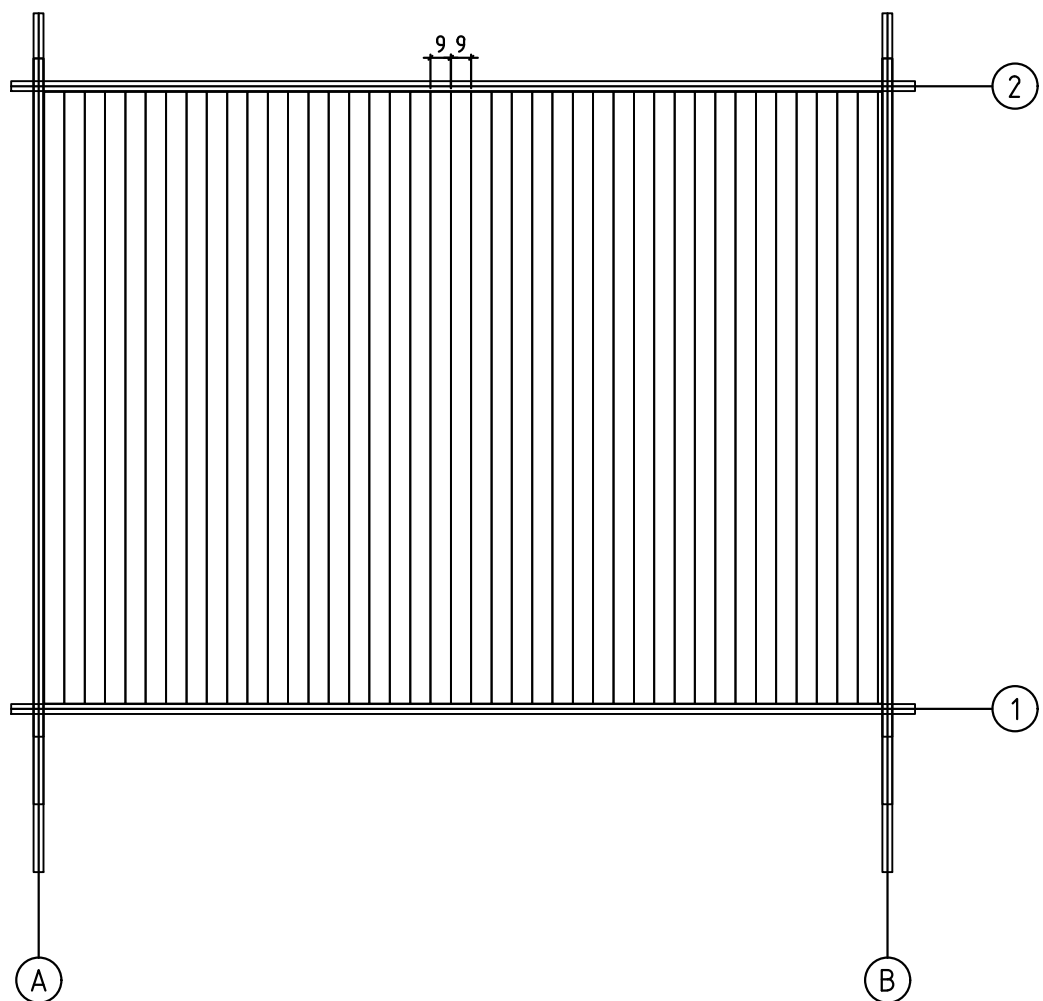



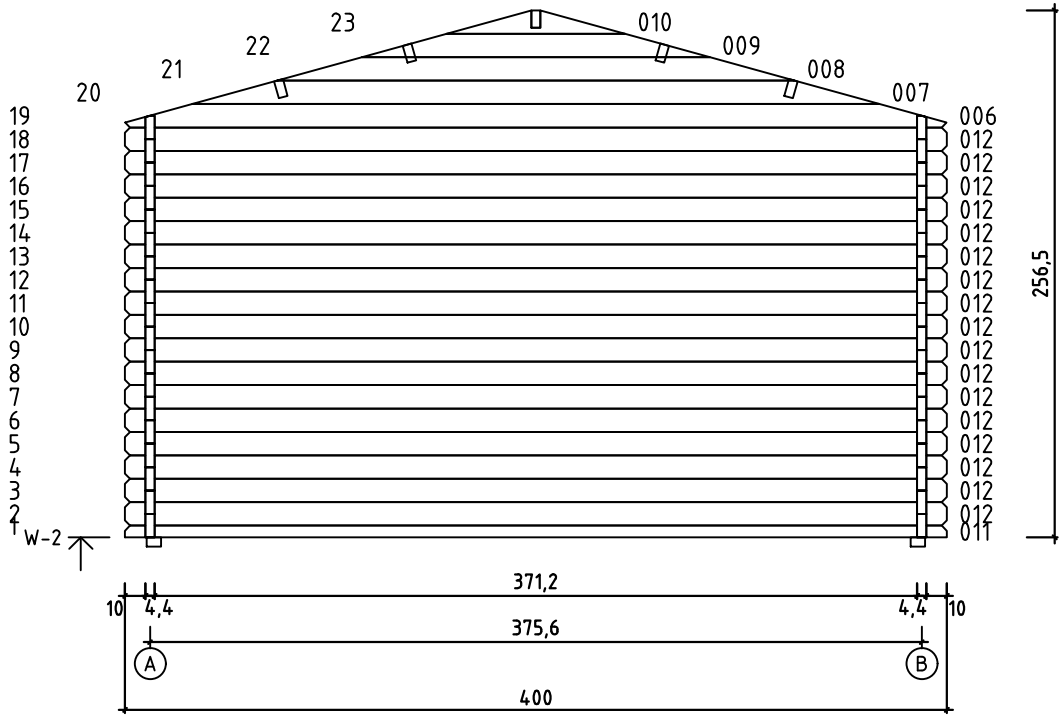
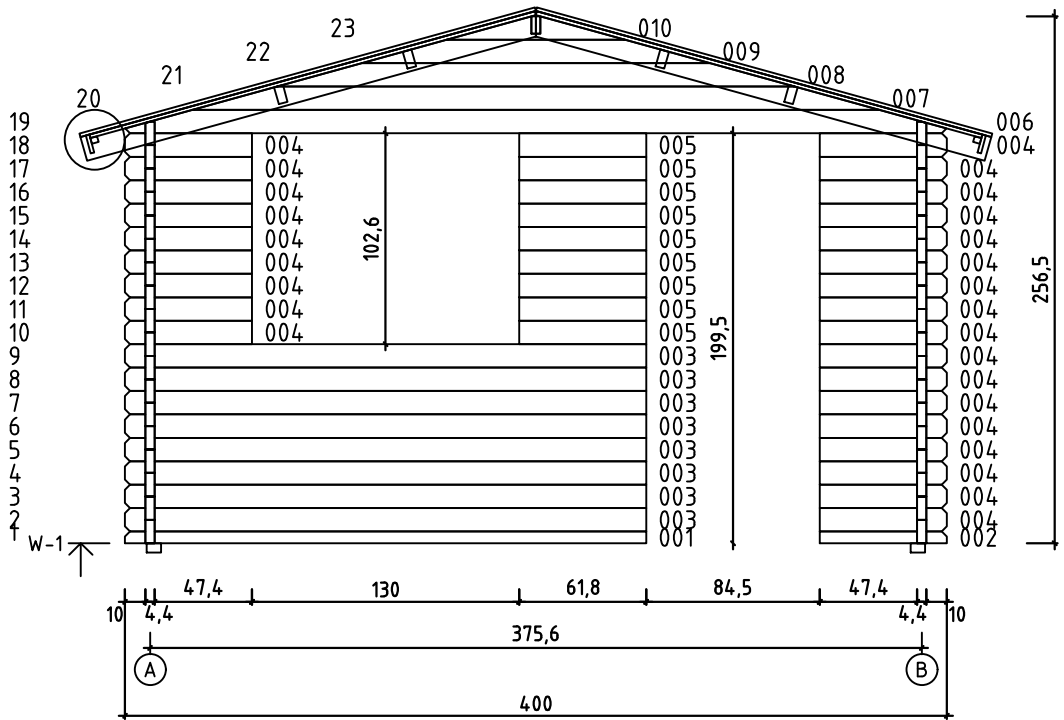
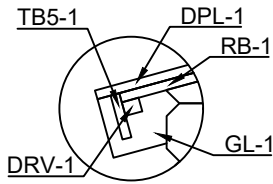





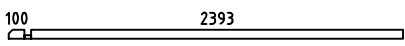
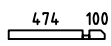
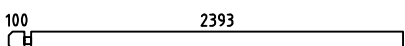
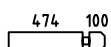
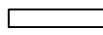
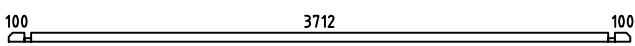
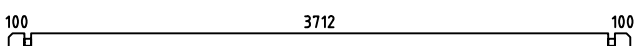
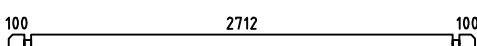
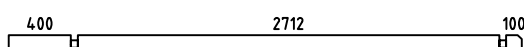
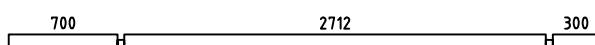
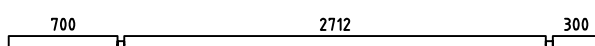
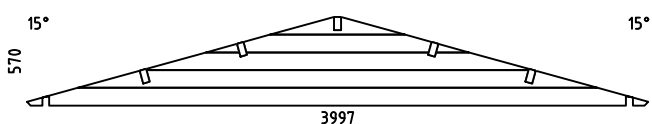
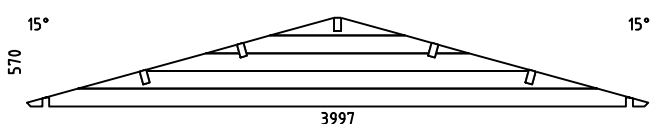

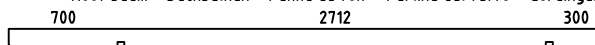



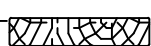

# Art.Nr. 4438102

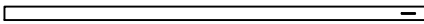
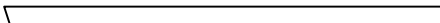
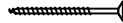
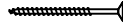
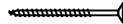
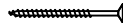
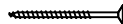
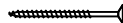

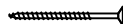
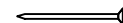

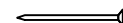

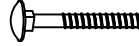



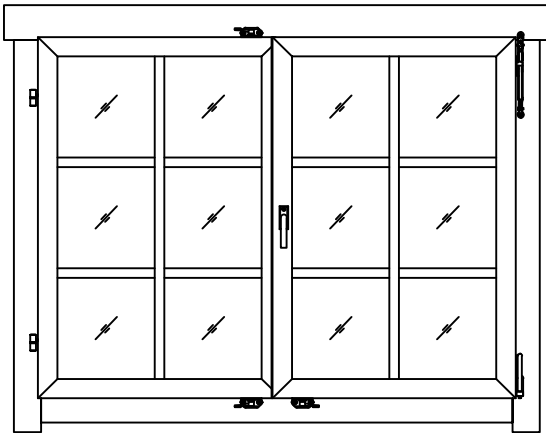
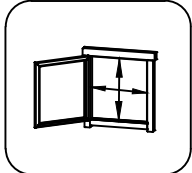

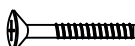

Pos	Piece list - Stückliste - Liste des pièces - Elementi - Stuklijst - Elementos - Tükitalabel 05.05.2025 Art.Nr. 4438102 8/9	Q	P (mm)	L (mm)
001		1	44x57	2537
002		1	44x57	618
003		8	44x114	2537
004		26	44x114	618
005		9	44x114	618
011 21184		1	44x57	4000
012 19774		17	44x114	4000
013 19773		32	44x114	3000
014 33289		2	44x114	3300
015		1	44x120	3800
016		1	44x120	3800
W1-1		1		
W2-1		1		
IAR2 5548	Foundation - Fundament - Fondation - Fondamenta - Fundering - Bastidor - Immutatud alusraam 	6	70x45	3650
IAR1 3902	Foundation - Fundament - Fondation - Fondamenta - Fundering - Bastidor - Immutatud alusraam 	2	70x45	2790
A-PR1	Roof beam - Dachbalken - Panne de toit - Perlina del tetto - Gordingen / dakbalk - Correa - Pärtin 	5	44x146	3800
RB-1 10041	Floor boards - Fussbodenbretter - Lame de plancher - Pavimento - Vloerhout - Tablero de suelo - Põrandalaud 	42	90x18.5	2708
RB-1 1115	Roof boards - Dachbretter - Voliges - Perlina per tetto - Dakhout - Tablero de tejado - Katuselaud 	86	90x18.5	2250
FL-1 30087	Floor fillet - Fussbodenleiste - Corniere de finition du plancher - Finitura per pavimento (battisco pa) - Vloerafwerklijst - Rodapié - Põrandaliist 		18x18	14
DPL-1 17895	Roofing felt fillet - Dachpappenleiste - Baguette de fixation du feutre bitumeux - Asse per fissaggio guaina bituminosa - Afdeklijst asfaltpapier - Moldura de fieltro para tejado - Katusepapiliist 	4	18x58	2300
TB5-1 2615	Fascia board - Traufbrett - Bandeau de toit - Finitura lati tetto - Gevellijst Tablero de alero - Räästalaud 	2	18x90	3800

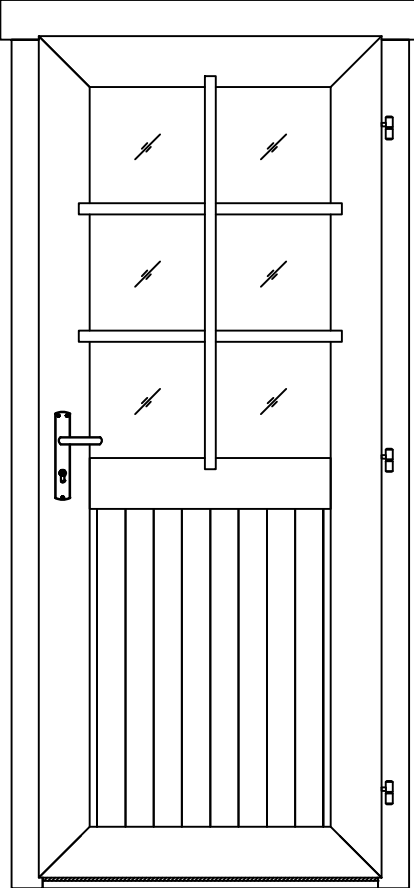
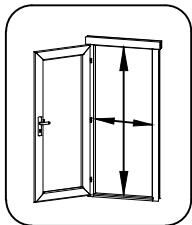
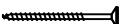
Pos	Piece list - Stückliste - Liste des pièces - Elementi - Stuklijst - Elementos - Tükítabel 05.05.2025 Art.Nr. 4438102 9/9	Q	P (mm)	L (mm)
DRV-1 2616	Roof edge reinforcement - Dachrandverstärkung - Corniere de renfort de bord de toit - Rinforzo x tetto - Dakrand versterking - Refuerzo de aleros - Räästatugevdus 	2	28x34	3800
KFS-1 2249	Storm protection - Sturmleiste - Latte anti-tempete - Protezione anti vento - Stormverankering / beveiliging - Moldura antitormenta - Tormikinnitusliist 	4	22x45	2050
GL-1 37107	Gable moulding - Giebelleiste - Planche de rive - Finitura per frontale e retro del tetto - Gevellijst - Tablero de frontón - Viilulaud 	4	18x120	2300
HS8 5105	Screw for gable segment - Schrauben für deckblatt - Vis pour fixation losange de finition - Viti x frontali tetto - Schroef voor gevelpunt segment - Tornillo para rombo - Kruvi rombile 	4	3.5x35	
HS9 5106	Screw for gable moulding - Schrauben für giebelleiste - Vis pour fixation planche de rive - Vite per fissare finiture davanti e dietro del tetto - Schroef voor gevellijst - Tornillo para tablero de frontón - Kruvi viilulauale 	32	3.5x50	
HS12 5109	Screw for fascia boards - Schrauben für traufbretter - Vis pour fixation bandeau de toit - Viti x striscia del tetto - Schroef voor gevellijst - Tornillo para tablero de alero - Kruvi räästalauale 	18	4x40	
HS12 5109	Screw for roof edge reinforcement - Schrauben für dachrandverstärkung - Vis pour fixation corniere renfort de bord de toit - Viti x rinforzo bordo tetto - Schroef voor dakrand versterking - Tornillo para refuerzo de alero - Kruvi räästatugevdusele 	18	4x40	
HS18 5113	Screw for foundation - Schrauben zur befestigung fundament - Vis de fixations des poutrelles de fondations - Viti x fondamenta - Schroef voor fundering - Tornillo para bastidor - Kruvi alusraamile 	12	5x120	
HS18 5113	Screw for gable - Schrauben für giebel - Vis pour fixation des pignons - Viti per timpano - Schroef voor gevelpunt - Tornillo para fijación de extremo de frontón - Kruvi kelba kinnitamiseks 	4	5x120	
HS18 5113	Screw for roof beams - Schrauben für dachbalken - Vis pour fixation pannes de toit - Viti per perline del tetto - Schroef voor gordingen / dakbalken - Tornillo para correas - Kruvi pärlinitele 	10	5x120	
HS16 5115	Screw for 1. wall beam - Schraube für 1. bohlenreihe - Vis de fixations 1ere rangée de madriers avec poutrelles de fondations - Vite fissaggio alle fondamenta - Schroef voor 1 wandbalk - Tornillo para medio tablero - Kruvi 1. seinareale 	8	5x90	
NF2 5127	Zn nail for floor fillet - Zn nägel für fussbodenleiste - Pointe pour corniere de finition du plancher - Chiodi x fissaggio pavimento - Spijker(nagel) voor vloer afdekljst - Clavo para rodapié - Nael põrandaliistule 	30	1.4x40	
SH4.4 32512	Hammer block - Schlagholz - Calle de frappe - Blocco di legno da usare come cuscinetto quando si usa il martello - Slagklos - Bloque de impacto - Löögiklots 	1		
SFS 5134	Nut for storm protection - Schraubenmutter für sturmleiste - Ecrou pour latte anti-tempete - Dado x asta protezione vento - Moer voor stormverankering - Tuerca para moldura antitormenta - Mutter tormikinnitusliistule 	8	D8	
NF5 5145	Zn nail for roofing felt fillet - Zn nägel für dachpappenleiste - Pointe pour baguette de fixation feutre bitumeux - Chiodi x carta bituminosa x tetto - Spijker(nagel) voor asfaltpapier afdekljst - Clavo de moldura de fieltro - Nael katusepapiliistule 	24	2x40	
NF4 5137	Zn nail for roof - Zn nägel für dachbretter - Pointe pour fixation voliges de toit - Chiodi x perline tetto - Spijker(nagel) voor dakhout - Clavo para tablero de tejado - Nael katuselauale 	352	2x50	
NF4 5137	Zn nail for floor - Zn nägel für fussbodenbretter - Clous pour plancher - Chiodi x perline pavimento - Spijker(nagel) voor vloer - Clavo para tablero de suelo - Nael põrandalauale 	258	2x50	
BFS 5159	Bolt for storm protection - Bolzen für sturmleiste - Boulon pour latte anti-tempete - Bullone x asta protezione vento - Bout voor stormankerlat - Perno de madera para moldura antitormenta - Puidupolt tormikinnitusliistule 	8	8x80	
GS 32614	Gable segment - Deckblatt - Losange de finition - Decorazione in legno x frontale tetto - Gevelpunt segment - Rombo - Romb 	2		
DFS 5126	Washer for storm protection - Dichtscheibe für sturmleiste - Rondelle pour latte anti-tempete - Rondella x asta protezione vento - Afdichtring voor storm strip - Arandela para moldura antitormenta - Seib tormikinnitusliistule 	8	D8	
14435	AKEN 1290x990 TAK.1.106.PSP.b DGC	1		
	UKS 835x1957 UK.2.056.PVP.MM DGC	1		

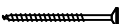
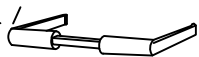
Pos	14.05.2015 Piece list - Stückliste - Liste des pièces - Elementi - Stuklijst - Tükitalabel 1290x990 TAK.1.106.PSP.b DGC	1/1	Q	P (mm)	L (mm)
<p data-bbox="258 145 1284 174">Glass size - Glasgröße - Taille de la vitre - Misura del vetro - Glas afmeting - Klaasi mõõt: 542x846 mm</p> <div data-bbox="577 241 1125 672" style="text-align: center;">  </div> <div data-bbox="1332 152 1524 324" style="text-align: right;">  <p data-bbox="1364 347 1492 376">1190x890 mm</p> </div>					
FS1	Window handle fittings - Fenstergriff - Poignee de fenetre - Maniglia c/ferramenta - Raamhendel -/grendel -/klink - Aknalink		1		
FSP	Bolt for window handle fittings - Bolzen für fenstergriff beschlag - Vis pour fixation poignee de fenetre - Bullone x apertura manuale finestra - Schroef voor raamhendel - Akna käepideme polt		2		
HS1	Screw for georgian bars - Schraube für sprossen - Vis pour croisillons - Viti per unire la griglia georgiana della finestra - Schroeven voor raamverdeling - Kruvi akna petteliistule		12	2.5x20	
HS4	Screw for window fillet - Schraube für glasleiste - Vis de filet de fenetre - Vite per assemblaggio finestra - Schroef voor glaslijst - Kruvi akna kokkuvaltšiliistule		3	3x30	

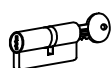
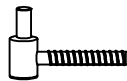
Pos	15.04.2025	Piece list - Stückliste - Liste des pièces - Elementi - Stuklijst - Tükitalabel 835x1957 UK.2.056.PVP.MM DGC	1/1	Q	P (mm)	L (mm)
		Glass size - Glasgröße - Taille de la vitre - Misura del vetro - Glas afmeting - Klaasi mõõt: 561x855 mm				
						
						 735x1875 mm
HS1	Screw for georgian bars - Schraube für sprossen - Vis pour croisillons - Viti per unire la griglia georgiana della finestra - Schroeven voor raamverdeling - Kruvi ukse petfeliistule		6	2.5x20		
HS16	Screw for door jamb - Schraube für Türrahmen - Vis de fixation partie haute avec montants du cadre de porte - Viti x fissaggio montanti porte - Schroef voor deurkozijn - Kruvi ukse lengile		4	5x90		
HS25	Screw for doorstep - Schrauben für swelle - Vis pour fixation barre de seuil - Vite per soglia della porta - Schroef voor deurdorpel - Kruvi lävepakule		2	4.5x65		
TL4	Door handle fittings - Türgriff - Poignée de porte - Maniglie - Deurhendel / klink - Ukse käepide VU		1			
TL5	Set of door lock covers - Schlossblenden - Set de garnitures de porte - Copertura serrature - Slot sluitplaat set - Ukse lukuplaat		1			
	Cylinder lock - Zylinderschloss - Barillet de porte - Serratura - Cylinder slot - Ukse lukusüdamik		1	30x35		
	Male bolt hinge for door - Türband - Partie male de paumelle de porte - Cerniera anube x porta - Scharnier bout - Ukse polthing isane		3			